

eircom Special Offers	Promotional Period
eircom Residential PSTN Connection Promotion (No 21 2014)	1st July 2014 to 1st July 2015
eircom Bundle Promotions (No 27 2014)	1st August 2014 to 31st July 2015
eircom Talktime for Business Bundle Promotion (No 28 2014)	2nd September 2014 to 1st September 2015
eircom Broadband Connection Promotion - Consumer	27th June 2014 to 26th June 2015
eircom Bundle Promotions (No 31 2014)	6th November 2014 to 31st October 2015
Setanta Sport & BT Sport 2 Month Free Promotion (No 38 2014)	1st January 2015 to 31st December 2015
eircom Voice Plan Opt-In Contract Promotion (No 37 2014)	5th January 2015 to 31st December 2015
3 Month Half Price Promotion for eVision Premium Add-Ons (No 39 2014)	15th January 2015 to 31st December 2015
eircom Promotions (No 1 2015)	commencing from 15th January 2015
eircom Consumer Promotions (No 4 2015)	17th February 2015 to 30th June 2015
eircom Business Broadband Bundle Promotion (No 6 2015)	5th March 2015 to 31st August 2015
eircom Bundle Promotions (No 8 2015)	7th March 2015 to 30th June 2015
eircom eVision online Promotions (No 9 2015)	13th March to 31st December 2015
eircom Talk Anytime Promotion (No 10 2015)	1st April 2015 to 31st December 2015
eircom Broadband Modem Promotion (No 11 2015)	1st April 2015 to 31st March 2016
eircom Consumer Once-off Bundle Promotion (No 13 2015)	16th April to 30th June 2015
eircom Consumer Re-Contracting Bundle Promotion (No 13 2015)	16th April 2015 to 31st December 2015
Sky Premium Add-On Trial (No 14 2015)	16th April 2015 to 31st December 2015
eircom Business Multi Product Bundle Promotion (no 17 2015)	1st May to 30th Sept 2015

see below for details

eircom Residential PSTN Connection Promotion
Promotional Period : 1st July 2014 to 1st July 2015 (inclusive)

EXCHANGE LINES (Connection and Removal)	Promotional Connection Offer		Normal Connection Charge €		Monthly Rental Charge €	
	ex. vat	inc. vat	ex.vat	inc.vat	ex.vat	inc.vat
Residential Standard Connection or Removal of Exchange line <i>(where the telephone line cannot be activated remotely, but requires manual intervention by an eircom technician, whether inside or outside of the premises where the service is required)</i>	zero		107.43	121.93	20.96	25.78
In-Situ Exchange Line Connections <i>(where the premises had previous eircom service and all line work is fully in place and the line can be electronically enabled)</i>	zero		20.65	25.40	20.96	25.78
Pre-Cabled Exchange Line Connections <i>(where the premises had previous eircom service and all line work is fully in place and the line can be electronically enabled)</i>	zero		44.04	49.99	20.96	25.78

Notes:

1. The offer applies to Residential In-Situ, Pre-Cabled and Standard PSTN Connection Orders and Residential In-Situ, Pre-Cabled and Standard Removal Orders received during the promotional period.
2. A maximum of one order per account may avail of the promotional offer.
3. The offer applies to Residential Accounts only. The line must be retained on a Residential Account for a minimum period of twelve months. If the line is transferred to a Business Account, or ceased and then re-instated on a Business Account, eircom reserves the right to apply the appropriate Connection fee.
4. Normal line rental charges will apply.
5. eircom reserves the right to withdraw this offering by giving relevant notice in accordance with normal requirements.
6. Usage of eircom PSTN service is deemed to be acceptance of the eircom general Terms and Conditions of telephone service.
7. A twelve month minimum term contract applies to all Residential Connections.

eircom broadband Connection Promotion - Consumer
Promotional Period from 27th June 2014 to 26th June 2015

Level	Bandwidth (up to)	Usage Limit (Download / Upload or Combined)	Promotional Credit	
			ex. vat	inc. vat
eircom Broadband Advanced	24576kbps Downstream /	30GB	€24.68	€30.36
eircom Broadband Advanced Unlimited	24576kbps Downstream /	Unlimited	€24.68	€30.36

Notes :

- 1 The eircom broadband connection promotion is available on new Broadband connections for eircom Broadband, eircom Broadband Advanced / Advanced Unlimited.
- 2 eircom broadband is subject to a 12-month minimum contract period. The contract period will be deemed to commence from the date of connection. Where an eircom broadband is ceased during the minimum contract period, eircom reserves the right to charge the customer the monthly rental for the balance of the un-expired contract period. Where the customer has received a free modem, they must return the modem to eircom within 14 days of the date of such cessation.
- 3 The promotional period is 27th June 2014 to 26th June 2015 inclusive.
- 4 The self-install option may not be available to all customers (e.g. eircom recommends a technician call-out for customers with monitored alarms, see charge below) details available on application. Where the self-install option is cancelled by the customer and the customer fails to return the self-install kit furnished to it, eircom reserves the right to charge the customer €81.81 ex.VAT.
- 5 eircom broadband is not necessarily available on all lines in all areas. Next Generation broadband is not currently available in all broadband enabled exchanges.
- 6 Offer subject to availability and line qualification.
- 7 Usage of eircom broadband service is deemed acceptance of the eircom broadband terms and conditions which shall prevail.
- 8 eircom reserve the right to withdraw this offer by giving relevant notice in accordance with normal requirements.
- 9 Customers who sign up during the promotional period will receive a discount dependent on what product is selected as per table above, all of which are inclusive of VAT.

Notes :

eircom price List (Amendment No 27)

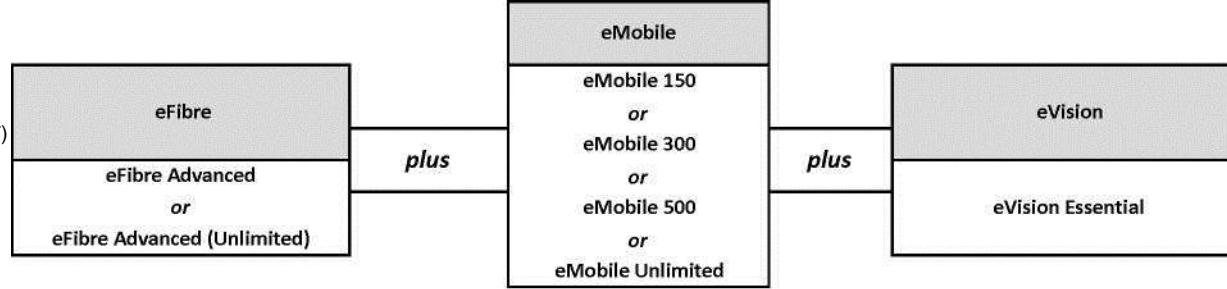

- promotion -

Number of Discount Instalments	Promotional Discount per Instalment		Total Promotional Discount	
	inc. VAT	€39.00	inc. VAT	€234.00
6	ex Vat	€31.71	ex Vat	€190.24

- 1 The eFibre, eMobile and eVision Triple Play New and Winback Bundle Promotion is made available to New and Winback customers for those customers who sign up between 1st August 2014 and 31st July 2015 inclusive and avail of an eTalk, eFibre, eMobile and eVision Quad Play Bundle Promotion as outlined above.
- 2 Qualifying customers who avail of an eFibre, eMobile and eVision Triple Play New and Winback Bundle Promotion will receive a monthly discount on €51.00 (inc VAT)/ €41.46 (ex VAT) on their bill applicable to the first 6 months following sign up to the bundle.
- 3 Customers must remain on one of the eFibre, eMobile and eVision promotional bundles throughout the 6 month promotional period in order to avail of all 6 monthly instalments of promotional discount.
- 4 The promotion is made available subject to a 18 month contract term being applied to the bundle. For the avoidance of doubt, early cease charges will apply where any eTalk, eFibre eMobile or eVision service is ceased within the minimum contract period.
- 5 Customers availing of the promotion who change any component (see component list in Part 4.1.9 of this price list) within the bundle (while retaining all components in the bundle) within the initial 3 months after availing of the promotion will continue to receive the bundle promotion for the outstanding term of the promotion only.
- 6 eircom reserves the right to withdraw this offer by giving relevant notice in accordance with normal requirements.
- 7 A customer may only avail of this promotion once.
- 8 Customers may not simultaneously avail of any other eFibre Bundle Promotion.
- 9 These terms and conditions will apply together with the terms and conditions governing the customer's use of the components included in the bundle.

- promotion -

(effective from 01/08/14 to 31/07/15)

eFibre and eTalk Dual Play Bundle Promotion(effective from 03/03/14 to 31/07/15)
eircom Price List (Amendment NO 27) 2014

Fixed Line	<i>plus</i>	eFibre Broadband
eTalk Off Peak <i>or</i> eTalk Anytime		eFibre Advanced <i>or</i> eFibre Advanced Unlimited

- promotion -

Number of Discount Instalments	Promotional Discount per Instalment		Total Promotional Discount	
	inc vat	ex. Vat	inc vat	ex. Vat
6	€15.00	€12.20	€90.00	€73.20

Notes :

- 1 The eFibre and eTalk Dual Play Bundle Promotion is made available to existing customers who are new to the bundle and apply for the promotion between 3rd March 2014 and 31st July 2015.
- 2 Customers who avail of an eTalk and eFibre bundle promotion will receive a monthly discount of €15.00 (inc VAT)/ €12.20 (ex VAT) on their bill applicable to the first 6 months following sign up to the bundle.
- 3 Customers must remain on one of the eTalk and eFibre promotional bundles throughout the 6 month promotional period in order to avail of all 6 monthly instalments of promotional discount.
- 4 The promotion is made available subject to a 18 month contract term being applied to the bundle. For the avoidance of doubt, early cease charges will apply where either the eTalk or eFibre service is ceased within the minimum contract period.
- 5 Customers availing of the promotion who change any component (see component list in Part 4.1.9 of this price list) within the bundle (while retaining all components in the bundle) within the initial 6 months after availing of the promotion will continue to receive the bundle promotion for the outstanding term of the promotion only.
- 6 eircom reserves the right to withdraw this offer by giving relevant notice in accordance with normal requirements.
- 7 A customer may only avail of this promotion once.
- 8 These terms and conditions will apply together with the terms and conditions governing the customer's use of the components included in the bundle.
- 9 A customer may not avail of more than one eFibre Bundle Promotion simultaneously.

(effective from 03/3/14 to 31/07/15)

- promotion -

eFibre and (effective from 03/03/14 to 31/07/15) eircom Price List (Amendment No 27) 2014	Number of Discount Instalments	Promotional Discount per Instalment		Total Promotional Discount	
	6	inc vat	ex. Vat	inc vat	ex. Vat
		€15.00	€12.20	€90.00	€73.20
	eMobile 300 or eMobile 500 or eMobile Unlimited		eFibre Advanced Unlimited		- promotion -

notes:

- 1 The eFibre and eMobile Dual Play Bundle Promotion is made available to existing customers who are new to the bundle and apply for the promotion between 3rd March 2014 and 31st July 2015.
- 2 Customers who avail of an eFibre and eMobile Dual Play Bundle Promotion will receive a monthly discount of €15.00 (inc VAT)/ €12.20 (ex VAT) on their bill applicable to the first 6 months following sign up to the bundle.
- 3 Customers must remain on one of the eFibre and eMobile promotional bundles throughout the 6 month promotional period in order to avail of all 6 monthly instalments of promotional discount.
- 4 The promotion is made available subject to a 18 mth contract term being applied to the bundle (24mth may apply depending on eMobile Handset chosen). For the avoidance of doubt, early cease charges will apply where either the eFibre or eMobile service is ceased within the min contract period.
- 5 Customers availing of the promotion who change any component (see component list in Part 4.1.9 of this price list) within the bundle (while retaining all components in the bundle) within the initial 6 months after availing of the promotion will continue to receive the bundle promotion for the outstanding term of the promotion only.
- 6 eircom reserves the right to withdraw this offer by giving relevant notice in accordance with normal requirements.
- 7 A customer may only avail of this promotion once.
- 8 These terms and conditions will apply together with the terms and conditions governing the customer's use of the components included in the bundle.
- 9 A customer may not avail of more than one eFibre Bundle Promotion simultaneously.

notes:

NGB Broad

(effective from 03/03/14 to 31/07/15)

eircom Price List (Amendment NO 27) 2014

Number of Discount Instalments	Promotional Discount per Instalment		Total Promotional Discount	
6	inc vat	ex. Vat	inc vat	ex. Vat
	€15.00	€12.20	€90.00	€73.20
	eMobile 300 or eMobile 500 or eMobile Unlimited		NGB Advanced Unlimited	

- promotion -

- 1 The NGB and eMobile Dual Play Bundle Promotion is made available to existing customers who are new to the bundle and apply for the promotion between 3rd March 2014 and 31st July 2015.
- 2 Customers who avail of an NGB and eMobile Dual Play Bundle Promotion will receive a monthly discount of €15.00 (inc VAT)/ €12.20 (ex VAT) on their bill applicable to the first 6 months following sign up to the bundle.
- 3 Customers must remain on one of the NGB and eMobile promotional bundles throughout the 6 month promotional period in order to avail of all 6 monthly instalments of promotional discount.
- 4 The promotion is made available subject to a 18 mth contract term being applied to the bundle (24mth may apply depending on eMobile Handset chosen). For the avoidance of doubt, early cease charges will apply where either the NGB or eMobile service is ceased within the min contract period.
- 5 Customers availing of the promotion who change any component (see component list in Part 4.1.9 of this price list) within the bundle (while retaining all components in the bundle) within the initial 6 months after availing of the promotion will continue to receive the bundle promotion for the outstanding term of the promotion only.
- 6 eircom reserves the right to withdraw this offer by giving relevant notice in accordance with normal requirements.
- 7 A customer may only avail of this promotion once.
- 8 These terms and conditions will apply together with the terms and conditions governing the customer's use of the components included in the bundle.
- 9 A customer may not avail of more than one eFibre Bundle Promotion simultaneously.

(effective from 03/03/14 to 31/07/15)

- promotion -

eTalk and eMobile Dual Play Bundle Promotion

(effective from 03/03/14 to 31/07/15)
eircom Price List (Amendment NO. 4.3)

Fixed Line	<i>plus</i>	Mobile
eTalk Off Peak <i>or</i> eTalk Anytime		eMobile 150 <i>or</i> eMobile 300 <i>or</i> eMobile 500 <i>or</i> eMobile Unlimited

- promotion -

Number of Discount Instalments	Promotional Discount per Instalment		Total Promotional Discount	
	inc vat	ex. Vat	inc vat	ex. Vat
6	€15.00	€12.20	€90.00	€73.20

notes:

- The eTalk and eMobile Dual Play Bundle Promotion is made available to existing customers who are new to the bundle and apply for the promotion between 3rd March 2014 and 31st July 2015.
- Customers who avail of an eTalk and eMobile Dual Play Bundle Promotion will receive a monthly discount of €15.00 (inc VAT)/ €12.20 (ex VAT) on their bill applicable to the first 6 months following sign up to the bundle.
- Customers must remain on one of the eTalk and eMobile promotional bundles throughout the 6 month promotional period in order to avail of all 6 monthly instalments of promotional discount.
- The promotion is made available subject to a 18 mth contract term being applied to the bundle (24mth may apply depending on eMobile Handset chosen). For the avoidance of doubt, early cease charges will apply where either the eTalk or eMobile service is ceased within the min contract period.
- Customers availing of the promotion who change any component (see component list in Part 4.1.9 of this price list) within the bundle (while retaining all components in the bundle) within the initial 6 months after availing of the promotion will continue to receive the bundle promotion for the outstanding term of the promotion only.
- eircom reserves the right to withdraw this offer by giving relevant notice in accordance with normal requirements.
- A customer may only avail of this promotion once.
- These terms and conditions will apply together with the terms and conditions governing the customer's use of the components included in the bundle.
- A customer may not avail of more than one eTalk Bundle Promotion simultaneously.

eFibre Broadband	<i>plus</i>	TV
eFibre Advanced <i>or</i> eFibre Advanced Unlimited		eVision Essential

Number of Discount Instalments	Promotional Discount per Instalment		Total Promotional Discount	
	inc vat	ex. Vat	inc vat	ex. Vat
6	€15.00	€12.20	€90.00	€73.20

1 The eFibre and eVision Dual Play Bundle Promotion is made available to existing customers who are new to the bundle and apply for the promotion (effective from 03/03/14 to 31/07/15) and 31st July 2015.

- promotion -

eFibre and eVision Dual Play Bundle Promotion

2 Customers who avail of an eFibre & eVision bundle promotion will receive their bundle at the discounted price outlined above for the first 6 months before reverting to the standard price as detailed above.
(effective from 01/08/14 to 31/07/15)
eircom Price List (Amendment NO 27) 2014 - promotion -

- 3 Customers must remain on one of the eFibre BB and eVision promotional bundles throughout the 6 month promotional period in order to avail of all 6 monthly instalments of promotional discount.
- 4 The promotion is made available subject to a 18 month contract term being applied to the bundle. For the avoidance of doubt, early cease charges will apply where either the eTalk, eFibre & eVision service is ceased within the minimum contract period.
- 5 Customers availing of the promotion who change any component (see component list in Part 4.1.9 of this price list) within the bundle (while retaining all components in the bundle) within the initial 6 months after availing of the promotion will continue to receive the bundle promotion at the relevant bundle price for the outstanding term of the promotion only.
- 6 eircom reserves the right to withdraw this offer by giving relevant notice in accordance with normal requirements.
- 7 A customer may only avail of this promotion once.
- 8 These terms and conditions will apply together with the terms and conditions governing the customer's use of the components included in the bundle.
- 9 A customer may not avail of more than one eFibre Bundle Promotion simultaneously.

eTalk, eFibre and eMobile Triple Play Bundle Promotion

(effective from 3rd March 2014 to 31st July 2015)
eircom Price List

Fixed Line	<i>plus</i>	eFibre Broadband	<i>plus</i>	Mobile
eTalk Off Peak		eFibre Advanced		eMobile 150
<i>or</i>		<i>or</i>		<i>or</i>
eTalk Anytime		eFibre Advanced Unlimited		eMobile 300
				<i>or</i>
				eMobile 500
				<i>or</i>
				eMobile Unlimited

- promotion -

Number of Discount Instalments	Promotional Discount per Instalment		Total Promotional Discount	
	inc vat	ex. Vat	inc vat	ex. Vat
6	€15.00	€12.20	€90.00	€73.20

Notes :

- 1 The eTalk, eFibre and eMobile Triple Play Bundle Promotion is made available to existing customers who are new to the bundle and apply for the promotion between 3rd March 2014 and 31st July 2015.
- 2 Customers who avail of an eTalk, eFibre and eMobile Triple Play Bundle Promotion will receive a monthly discount of €15.00 (inc VAT)/ €12.20 (ex VAT) on their bill applicable to the first 6 months following sign up to the bundle.
- 3 Customers must remain on one of the eTalk, eFibre and eMobile Triple Play promotional bundles throughout the 6 month promotional period in order to avail of all 6 monthly instalments of promotional discount.
- 4 The promotion is made available subject to a 18 month contract term being applied to the bundle. For the avoidance of doubt, early cease charges will apply where either any eTalk, eFibre or eMobile service is ceased within the minimum contract period.
- 5 Customers availing of the promotion who change any component (see component list in Part 4.1.9 of this price list) within the bundle (while retaining all components in the bundle) within the initial 6 months after availing of the promotion will continue to receive the bundle promotion for the outstanding term of the promotion only.
- 6 eircom reserves the right to withdraw this offer by giving relevant notice in accordance with normal requirements.
- 7 A customer may only avail of this promotion once.
- 8 These terms and conditions will apply together with the terms and conditions governing the customer's use of the components included in the bundle.
- 9 A customer may not avail of more than one eFibre Bundle Promotion simultaneously.

Fixed Line	<i>plus</i>	NGB Broadband	<i>plus</i>	Mobile
eTalk Off Peak		NGB Advanced		eMobile 150
<i>or</i>		<i>or</i>		<i>or</i>
eTalk Anytime		NGB Advanced Unlimited		eMobile 300
				<i>or</i>
				eMobile 500
				<i>or</i>
				eMobile Unlimited

(effective from 3rd March 2014 to 31st July 2015)

Number of Discount Instalments	Promotional Discount per Instalment		Total Promotional Discount	
	inc vat	ex. Vat	inc vat	ex. Vat
6	€15.00	€12.20	€90.00	€73.20

- promotion -

eTalk, NGB Broadband and eMobile Triple Play Bundle Promotion

Notes: (effective from 03/03/14 to 31/07/15)

1 The eTalk, NGB Broadband and eMobile Triple Play Bundle Promotion is made available to existing customers who are new to the bundle and apply for the promotion between 3rd March 2014 and 31st July 2015. - promotion -

- 2 Customers who avail of an eTalk, NGB Broadband and eMobile Triple Play Bundle Promotion will receive a monthly discount of €15.00 (inc VAT)/ €12.20 (ex VAT) on their bill applicable to the first 6 months following sign up to the bundle.
- 3 Customers must remain on one of the eTalk, NGB Broadband and eMobile Triple Play promotional bundles throughout the 6 month promotional period in order to avail of all 6 monthly instalments of promotional discount.
- 4 The promotion is made available subject to a 18 month contract term being applied to the bundle. For the avoidance of doubt, early cease charges will apply where either any eTalk, NGB Broadband or eMobile service is ceased within the minimum contract period.
- 5 Customers availing of the promotion who change any component (see component list in Part 4.1.9 of this price list) within the bundle (while retaining all components in the bundle) within the initial 6 months after availing of the promotion will continue to receive the bundle promotion for the outstanding term of the promotion only.
- 6 eircom reserves the right to withdraw this offer by giving relevant notice in accordance with normal requirements.
- 7 A customer may only avail of this promotion once.
- 8 These terms and conditions will apply together with the terms and conditions governing the customer's use of the components included in the bundle.
- 9 A customer may not avail of more than one NGB Broadband Bundle Promotion simultaneously.

Fixed Line	<i>plus</i>	eFibre Broadband	<i>plus</i>	TV
eTalk Off Peak <i>or</i> eTalk Anytime		eFibre Advanced <i>or</i> eFibre Advanced Unlimited		eVision Essential

Number of Discount Instalments	Promotional Discount per Instalment		Total Promotional Discount	
6	inc vat	ex. Vat	inc vat	ex. Vat
	€15.00	€12.20	€90.00	€73.20

1 The eTalk, eFibre and eVision Triple Play Bundle Promotion is made available to existing customers who are new to the bundle and apply for the promotion between 3rd March 2014 and 31st July 2015.

- 2 Customers who avail of an eTalk, eFibre & eVision bundle promotion will receive their bundle at the discounted price outlined above for the first 6 months before reverting to the standard price as detailed above.
- 3 Customers must remain on one of the eTalk, eFibre BB and eVision promotional bundles throughout the 6 month promotional period in order to avail of all 6 monthly instalments of promotional discount.
- 4 The promotion is made available subject to a 18 month contract term being applied to the bundle. For the avoidance of doubt, early cease charges will apply where either the eTalk, eFibre & eVision service is ceased within the minimum contract period.
- 5 Customers availing of the promotion who change any component (see component list in Part 4.1.9 of this price list) within the bundle (while retaining all components in the bundle) within the initial 6 months after availing of the promotion will continue to receive the bundle promotion at the relevant bundle price for the outstanding term of the promotion only.

(effective from 03/03/14 to 31/07/15)

6 eircom reserves the right to withdraw this offer by giving relevant notice in accordance with normal requirements.

- promotion -

eTalk + eFibre and eVision Triple Play Bundle Promotion

(effective from 01/08/14 to 31/07/15)

7 A customer may only avail of this promotion once.

- promotion -

8 These terms and conditions will apply together with the terms and conditions governing the customer's use of the components included in the bundle.

9 A customer may not avail of more than one eFibre Bundle Promotion simultaneously.

(effective from 01/08/14 to 31/07/15)

- promotion -

eFibre and eTalk Dual Play €5 Bundle Promotion

(effective from 03/03/14 to 31/07/15)
eircom Price List (Amendment No 27) 2014

Fixed Line	<i>plus</i>	eFibre Broadband
eTalk Off Peak <i>or</i> eTalk Anytime		eFibre Advanced <i>or</i> eFibre Advanced Unlimited

- promotion -

Number of Discount Instalments	Promotional Discount per Instalment		Total Promotional Discount	
	inc vat	ex. Vat	inc vat	ex. Vat
6	€5.00	€4.07	€30.00	€24.42

Notes :

- 1 The eFibre and eTalk Dual Play Bundle Promotion is made available to existing eircom existing customers who migrate to the eTalk and eFibre Dual Play Bundle between 3rd March 2014 and 31st July 2015.
- 2 Customers who avail this promotion will receive a monthly discount of €5.00 (inc VAT)/ €4.07 (ex VAT) on their bill applicable to the first 6 months following sign up to the bundle.
- 3 Customers must remain on one of the eTalk and eFibre promotional bundles throughout the 6 month promotional period in order to avail of all 6 monthly instalments of promotional discount.
- 4 The promotion is made available subject to a 18 month contract term being applied to the bundle. For the avoidance of doubt, early cease charges will apply where either the eTalk or eFibre service is ceased within the minimum contract period.
- 5 Customers availing of the promotion who change any component (see component list in Part 4.1.9 of this price list) within the bundle (while retaining all components in the bundle) within the initial 6 months after availing of the promotion will continue to receive the bundle promotion for the outstanding term of the promotion only.
- 6 eircom reserves the right to withdraw this offer by giving relevant notice in accordance with normal requirements.
- 7 A customer may only avail of this promotion once.
- 8 These terms and conditions will apply together with the terms and conditions governing the customer's use of the components included in the bundle.
- 9 A customer may not avail of more than one eFibre Bundle Promotion simultaneously.

Mobile	<i>plus</i>	eFibre Broadband	<i>plus</i>	TV
eMobile 150 <i>or</i> eMobile 300 <i>or</i> eMobile 500 <i>or</i> eMobile Unlimited		eFibre Advanced <i>or</i> eFibre Advanced Unlimited		eVision Essential

Number of Discount Instalments	Promotional Discount per Instalment		Total Promotional Discount	
	inc vat	ex. Vat	inc vat	ex. Vat
6	€15.00	€12.20	€90.00	€73.20

(ef

- promotion -

Notes :

eMobile, eFibre and eVision Triple Play Bundle Promotion

1 The eMobile, eFibre and eVision Triple Play Bundle Promotion is made available to existing customers who are new to the bundle and apply for the promotion between 3rd March 2014 and 31st July 2015.
(effective from 03/03/14 to 31/07/15)

eircom Price List (Amendment No 27) 2014

- promotion -

- 2 Customers who avail of an eMobile, eFibre and eVision Triple Play Bundle Promotion will receive a monthly discount of €15.00 (inc VAT)/ €12.20 (ex VAT) on their bill applicable to the first 6 months following sign up to the bundle.
- 3 Customers must remain on one of the eMobile, eFibre and eVision Triple Play promotional bundles throughout the 6 month promotional period in order to avail of all 6 monthly instalments of promotional discount.
- 4 The promotion is made available subject to a 18 month contract term being applied to the bundle. For the avoidance of doubt, early cease charges will apply where either any eMobile, eFibre or eVision service is ceased within the minimum contract period.
- 5 Customers availing of the promotion who change any component (see component list in Part 4.1.9 of this price list) within the bundle (while retaining all components in the bundle) within the initial 6 months after availing of the promotion will continue to receive the bundle promotion for the outstanding term of the promotion only.
- 6 eircom reserves the right to withdraw this offer by giving relevant notice in accordance with normal requirements.
- 7 A customer may only avail of this promotion once.
- 8 Customers availing of this promotion may on an opt-in basis simultaneously avail of the discount of €10 (inc VAT) per month for 6 months that is applied by the applied by the eMobile, eFibre and eVision Triple Play Bundle Promotion as outlined in the eircom Price List, but may not simultaneously avail of any other eFibre Bundle Promotion.
- 9 These terms and conditions will apply together with the terms and conditions governing the customer's use of the components included in the bundle.

eTalk, eFibre, eMobile and eVision Quad Play Bundle Promotion

(effective from 03/03/14 to 31/07/15)

eircom price List (Amendment No 27) 2014

- promotion -

Fixed Line	<i>plus</i>	eFibre Broadband	<i>plus</i>	Mobile	<i>plus</i>	TV
eTalk Off Peak		eFibre Advanced		eMobile 150		eVision Essential
<i>or</i>		<i>or</i>		<i>or</i>		
eTalk Anytime		eFibre Advanced Unlimited		eMobile 300		
				<i>or</i>		
				eMobile 500		
				<i>or</i>		
				eMobile Unlimited		

Number of Discount Instalments	Promotional Discount per Instalment		Total Promotional Discount	
	inc vat	ex. Vat	inc vat	ex. Vat
6	€15.00	€12.20	€90.00	€73.20

- 1 The eTalk, eFibre, eMobile and eVision Quad Play Bundle Promotion is made available to existing customers who are new to the bundle and apply for the promotion between 3rd March 2014 and 31st July 2015.
- 2 Customers who avail of an eTalk, eFibre, eMobile and eVision Quad Play Bundle Promotion will receive a monthly discount of €15.00 (inc VAT)/ €12.20 (ex VAT) on their bill applicable to the first 6 months following sign up to the bundle.
- 3 Customers must remain on one of the eTalk, eFibre, eMobile and eVision Quad Play promotional bundles throughout the 6 month promotional period in order to avail of all 6 monthly instalments of promotional discount.
- 4 The promotion is made available subject to a 18 month contract term being applied to the bundle. For the avoidance of doubt, early cease charges will apply where either any eTalk, eFibre, eMobile and eVision Quad Play service is ceased within the minimum contract period.
- 5 Customers availing of the promotion who change any component (see component list in Part 4.1.9 of this price list) within the bundle (while retaining all components in the bundle) within the initial 6 months after availing of the promotion will continue to receive the bundle promotion for the outstanding term of the promotion only.
- 6 eircom reserves the right to withdraw this offer by giving relevant notice in accordance with normal requirements.
- 7 A customer may only avail of this promotion once.
- 8 These terms and conditions will apply together with the terms and conditions governing the customer's use of the components included in the bundle.
- 9 A customer may not avail of more than one eFibre Bundle Promotion simultaneously.

(effective from 01/08/14 to 31/07/15)

- promotion -

Fixed Line	<i>plus</i>	NGB Broadband
eircom Talk Off Peak <i>or</i> eircom Talk Anytime		NGB Advanced <i>or</i> NGB Advanced Unlimited

Number of Discount Instalments	Promotional Discount per Instalment		Total Promotional Discount	
	inc vat	ex. Vat	inc vat	ex. Vat
6	€15.00	€12.20	€90.00	€73.20

Notes :

- 1 The NGB and eircom Talk Dual Play Bundle Promotion is made available to existing customers who are new to the bundle and apply for the promotion between 1st August 2014 and 31st July 2015.
- 2 Customers who avail of an eircom Talk and NGB bundle promotion will receive a monthly discount of €15.00 (inc VAT)/ €12.20 (ex VAT) on their bill applicable to the first 6 months following sign up to the bundle.
- 3 Customers must remain on one of the eircom Talk and NGB promotional bundles throughout the 6 month promotional period in order to avail of all 6 monthly instalments of promotional discount.
- 4 The promotion is made available subject to a 12 month contract term being applied to the bundle. For the avoidance of doubt, early cease charges will apply where either the eircom Talk or NGB service is ceased within the minimum contract period.
- 5 Customers availing of the promotion who change any component within the bundle (while retaining all components in the bundle) within the initial 6 months after availing of the promotion will continue to receive the bundle promotion for the outstanding term of the promotion only.
- 6 eircom reserves the right to withdraw this offer by giving relevant notice in accordance with normal requirements.
- 7 A customer may only avail of this promotion once.
- 8 These terms and conditions will apply together with the terms and conditions governing the customer's use of the components included in the bundle.
- 9 A customer may not avail of more than one NGB Bundle Promotion simultaneously.

Fixed Line	<i>plus</i>	eFibre Broadband	<i>plus</i>	TV
eTalk Off Peak <i>or</i> eTalk Anytime		eFibre Advanced <i>or</i> eFibre Advanced Unlimited		eVision Essential

Number of Discount Instalments	Promotional Discount per Instalment		Total Promotional Discount	
	inc vat	ex. Vat	inc vat	ex. Vat
12	€15.00	€12.20	€180.00	€146.34

Notes:

- 1 The eircom eVision Online TV Bundle promotion (the "Promotion") is available to all new and existing eircom customers who orders eVision online at www.eir.ie (effective from 01/08/14 to 31/07/15) as part of one of the Talk and eFibre bundles set out above (Triple Play Bundle). ***There are a limited number of 12 month offers available to customers who order by means other than Online.** - promotion -

eircom eVision Online* TV Bundle Promotion

(effective from 26/03/14 to 31/07/15)

eircom Price List (Amendment NO 27) 2014

- promotion -

- 2 If you sign up to a Triple Play Bundle on or before **31st July 2015** this Promotion entitles you to receive eircom's basic eVision TV Service ('eVision Essential TV Pack') for free for the first twelve (12) months of your Triple Play Bundle
- 3 Customers who avail of the Promotion will receive their Triple Play Bundle at the discounted price for the first twelve (12) months before reverting to the standard price for their Triple Play Bundle as detailed above for the remainder of the term of their Triple Play Bundle
- 4 The minimum subscription term of each Triple Play Bundle is 18 months (the "Minimum Term").
- 5 Customers already availing of any promotional discounts for eircom voice or broadband products may lose such promotional discounts when availing of the Triple Play Bundle
- 6 If you cancel your eVision TV Service during the Minimum Term you will be liable to pay the applicable early cease charge in respect of the eVision TV Service as per the eircom Price List at www.eir.ie/pricing ("eircom Price List"), and you will be automatically moved onto eircom's dual play bundle for eircom's eFibre broadband service and eTalk telephone service.
- 7 If you cancel your eircom eFibre broadband service during the Minimum Term, your eVision TV Service will also terminate and you will be liable for early cease charges for both the eVision TV Service and the eircom eFibre broadband service as set out in the eircom Price List.
- 8 This Promotion is available to customers new to eVision only
- 9 eircom reserves the right to withdraw this Promotion by giving relevant notice in accordance with normal requirements
- 10 Usage of the services in the Triple Play Bundle by customer is deemed to constitute acceptance of eircom's terms and conditions for each of the services in the Triple Play Bundle, as well as eircom's general terms and conditions of service as set out at www.eir.ie/Pricing (the "Terms").
- 11 The terms and conditions of this Promotion are in addition to the Terms. In the event of a conflict between these terms and the Terms these terms shall take precedence.

(effective from 26/03/14 to 31/07/15)

- promotion -

eircom eFibre Unlimited and eircom Broadband Advanced Unlimited Online Promotion

eircom Price List (Amendment No 34) 2014

Promotion Period: 3 December 2014 to 31 July 2015

- promotion -

Number of Discount Instalments	Promotional Discount per Instalment		Total Promotional Discount	
	inc vat	ex. Vat	inc vat	ex. Vat
6	€10.00	€8.13	€60.00	€48.78

Notes :

1 This promotion is made available to new and winback customers who sign up Online during the promotion period and avail of one of the qualifying bundles as listed below.

- eTalk / eTalk 2014 and eFibre Advanced Unlimited
- eTalk / eTalk 2014 and eircom Broadband Advanced Unlimited
- eFibre Advanced Unlimited and eMobile
- eFibre Advanced Unlimited and eVision
- eTalk / eTalk 2014, eFibre Advanced Unlimited and eMobile
- eTalk / eTalk 2014, eircom Broadband Advanced Unlimited and eMobile
- eFibre Advanced Unlimited, eVision and eMobile
- eTalk / eTalk 2014, eFibre Advanced Unlimited, eVision and eMobile
- eircom Talk / Talk 2014 and eircom Broadband Advanced Unlimited

2 Customers who avail of the promotion will receive a monthly credit of €10.00 per month (inc VAT) on their eircom bill for 6 months, provided they continue to avail of a qualifying bundle as listed. For the purposes of bill display the discount may be subsumed into the bundle price displayed on the bill.

3 Customers availing of any of the following promotions may not simultaneously avail of this promotion

- eircom Talk / Talk 2014 Anytime / Off-Peak Bundle Contract Promotion (No 9 2013)
- eircom Pricing Flexibility Promotion (No 26 2013)
- eircom Voice Plan Opt-In Contract Promotion (No 35 2013)
- eircom Consumer Voice Promotion (No 4 2014)
- eircom Talk / Talk 2014 Promotions (No 9 2014)
- eircom Talk / Talk 2014 Off-Peak €10 Promotion
- eircom Talk / Talk 2014 Anytime €15 Promotion
- eircom Talk / Talk 2014 Anytime Promotion

4 Where a customer ceases to avail of any service in their bundle, the customer will forfeit their entitlement to the promotion.

5 eircom reserves the right to withdraw this offering by giving relevant notice in accordance with normal requirements.

6 These terms and conditions will apply together with the terms and conditions governing the customer's use of the services included in their bundle.

Number of Discount Instalments	Promotional Discount per Instalment		Total Promotional Discount	
	inc vat	ex. Vat	inc vat	ex. Vat
6	€5.00	€4.07	€30.00	€24.42

Notes :

1 The Consumer Bundle Contract Promotion is made available to existing eircom eFibre bundle customers on a opt-in basis in exchange for re-starting the minimum contract term.

Consumer Bundle Contract Promotion

(effective from 01/08/14 to 31/07/15)

eircom Price List (Amendment No 27) 2014

- promotion -

- 2 Customers who avail this promotion will receive a monthly discount of €5.00 (inc VAT)/ €4.07 (ex VAT) on their bill applicable to the first 6 months following sign up to the bundle.
- 3 Customers must remain on one of the promotional bundles throughout the 6 month promotional period in order to avail of all 6 monthly instalments of promotional discount.
- 4 The promotion is made available subject to a 18 month contract term being applied to the bundle. For the avoidance of doubt, early cease charges will apply where either the eTalk or eFibre service is ceased within the minimum contract period.
- 5 Customers availing of the promotion who change any component (see component list in Part 4.1.9 of this price list) within the bundle (while retaining all components in the bundle) within the initial 6 months after availing of the promotion will continue to receive the bundle promotion for the outstanding term of the promotion only.
- 6 eircom reserves the right to withdraw this offer by giving relevant notice in accordance with normal requirements.
- 7 A customer may only avail of this promotion once.
- 8 These terms and conditions will apply together with the terms and conditions governing the customer's use of the components included in the bundle.
- 9 A customer may not avail of more than one eFibre Bundle Promotion simultaneously.

Talktime for Business Level	PSTN		ISDN		PSTN		ISDN	
	with eircom Broadband Business Lite Plus or eircom Business Lite Plus Next Generation or eFibre Business Professional				with eircom Broadband Business Starter or eFibre Business Advanced			
	Standard Monthly Price ex. vat	Promotional Monthly Offer ex. Vat	Standard Monthly Price ex. vat	Promotional Monthly Offer ex. Vat	Standard Monthly Price ex. vat	Promotional Monthly Offer ex. Vat	Standard Monthly Price ex. vat	Promotional Monthly Offer ex. Vat
1	€53.00	€36.00	€64.55	€47.55	€66.00	€49.00	€77.55	€60.55
2	€63.97	€46.97	€75.52	€58.52	€76.97	€59.97	€88.52	€71.52
3	€76.51	€59.51	€88.06	€71.06	€89.51	€72.51	€101.06	€84.06
4	€95.39	€78.39	€106.94	€89.94	€108.39	€91.39	€119.94	€102.94
5	€125.24	€108.24	€136.79	€119.79	€138.24	€121.24	€149.79	€132.79
6	€157.76	€140.76	€169.31	€152.31	€170.76	€153.76	€182.31	€165.31
7	€191.28	€174.28	€202.83	€185.83	€204.28	€187.28	€215.83	€198.83

Notes :

1. The eircom Talktime for Business and eircom Broadband bundles are made available at the promotion prices outlined above to customers who apply for the promotion between 2nd September 2014 and 1st September 2015 inclusive.
(effective from 13/04/14 to 31/07/15)
2. Customers who avail of the above promotion will receive their bundle at a promotional price outlined above for the first 12 months before reverting to the standard price as

- promotion -

set out above.

eircom Price List (Amendment No 28) 2014

eircom Talktime for Business / Broadband Bundle Promotion
(promotional period: 2nd September 2014 to 1st September 2015)

3. The promotion is made available subject to a 12 month contract term being applied to the bundle. For the avoidance of doubt, early cease charges will apply where either the Talktime for Business plan or the eircom broadband service is ceased within the minimum contract period.
4. eircom may at its absolute discretion, without further notice to the Customer, withdraw this offer from the Customer's telephone account.
5. This Agreement is terminable by the Customer giving notice to the Company. On termination of this Agreement by either party, all associated features of the Facility shall no longer apply to the Customer's account except for the Phone Services, unless expressly ceased by the Customer, the Phone Services shall remain on the Customer's exchange line and shall be charged for at standard rates. Where the Facility is terminated by the Customer in a Billing Cycle all calls charged for in that Billing Cycle in which the Facility is terminated by the Customer shall be charged for at standard rates.
6. These terms and conditions together with the current eircom Talktime for Business voice plan terms and conditions and the eircom Broadband terms and conditions (as specified in the eircom Price List), constitute the entire agreement between the parties in relation to the Facility.
- 7 Customers availing of this eircom Talktime for Business / Broadband Bundle promotion cannot simultaneously avail of any other Talktime for Business promotions.

eircom Consumer Re-Contracting Bundle Promotion

(effective from 05/11/14 to 31/10/15)

eircom Price List (Amendment No 31) 2014

- promotion -

Available with any <i>Dual play</i> bundle that includes:		
Fixed Line	and	Broadband
eTalk (2014) Off Peak <i>or</i> eTalk (2014) Anytime <i>or</i> eircom Talk (2014) Weekend <i>or</i> eircom Talk (2014) Off Peak <i>or</i> eircom Talk (2014) Anytime		Any Consumer Broadband Package

	Number of Discount Instalments	Promotional Discount per Instalment		Total Promotional Discount	
Option 1	4	inc vat	ex. Vat	inc vat	ex. Vat
		€5.00	€4.07	€20.00	€16.28
	Number of Discount Instalments	Promotional Discount per Instalment		Total Promotional Discount	
Option 2	12	inc vat	ex. Vat	inc vat	ex. Vat
		€3.00	€2.44	€36.00	€29.27

Notes :

- 1 The eircom Consumer Re-Contracting Bundle Promotion is made available to customers availing of a new or amended eircom Talk 2014 or eTalk (2014) and Broadband bundle from November 5th 2014 to October 31st 2015.
- 2 Customers who avail of the eircom Consumer Re-Contracting Bundle Promotion may choose one of the discount options outlined above.
- 3 Customers must remain on one of their eircom Talk (2014)/ eTalk (2014) and Broadband bundle throughout the applicable promotional period in order to avail of all monthly instalments of promotional discount.
- 4 The promotion is made available subject to a 12 month (eircom Talk (2014) Bundles) or 18 month (eTalk (2014) Bundle) contract term being applied to the bundle. For the avoidance of doubt, early cease charges will apply where any service is ceased within the minimum contract period.
- 5 eircom reserves the right to withdraw this offer by giving relevant notice in accordance with normal requirements.
- 6 A customer may only avail of this promotion once.
- 7 Customers availing of this promotion may not avail of any other bundle promotion
- 8 These terms and conditions will apply together with the terms and conditions governing the customer's use of the components included in the bundle.

(effective from 05/11/14 to 31/10/15)

- promotion -

eircom Consumer €5 x 12 Bundle Promotion

(effective from 05/11/14 to 31/10/15)

eircom Price List (Amendment No 31) 2014

- promotion -

Available with any multi product bundle that includes:		
Fixed Line	or	Broadband
eTalk (2014) Off Peak or eTalk (2014) Anytime or eircom Talk (2014) Off Peak or eircom Talk (2014) Anytime		Any Consumer Broadband Package

Number of Discount Instalments	Promotional Discount per Instalment		Total Promotional Discount	
12	inc vat	ex. Vat	inc vat	ex. Vat
	€5.00	€4.07	€60.00	€48.84

Notes :

- 1 The eircom Consumer €5 x 12 Bundle Promotion is made available to customers availing of a new or amended eircom Talk (2014) or eTalk (2014) and Broadband bundle (as available from November 5th) from November 5th 2014 to October 31st 2015.
- 2 Customers who avail of the Promotion will receive a discount of €5 per month on their eircom bill for 12 months following opt-in to the promotion.
- 3 Customers must remain on one of their eircom Talk (2014)/ eTalk (2014) or Broadband bundle throughout the applicable promotional period in order to avail of all monthly instalments of promotional discount.
- 4 The promotion is made available subject to a 12 month (eircom Talk (2014) Bundles) or 18 month (eTalk (2014) Bundle) contract term being applied to the bundle. For the avoidance of doubt, early cease charges will apply where any service is ceased within the minimum contract period.
- 5 eircom reserves the right to withdraw this offer by giving relevant notice in accordance with normal requirements.
- 6 A customer may only avail of this promotion once.
- 7 Customers availing of this promotion may not avail of any other bundle promotion.
- 8 These terms and conditions will apply together with the terms and conditions governing the customer's use of the components included in the bundle.

Monthly Promotional Discount		Duration of Promotion	Total Value over full Promotional Period	
Inc. VAT	Ex. VAT	4 month	Inc. VAT	Ex. VAT
€5.00	€4.07			€20.00

Notes:

- 1 The Consumer Voice Promotion is available to Residential customers availing of the standard Call Charges or those available of the following Consumer voice packages: eircom Talk Anytime, eircom Talk Off-Peak, eircom Talk Weekend, eircom Talktime 200, eircom Talktime After Hours, eircom Talktime Anytime, eircom Talktime Anytime UK, eircom Talktime Basic, eircom Talktime Chatter, eircom Talktime Everyday, eircom Talktime Family, eircom Talktime Family Anytime, eircom Talktime Friends, eircom Talktime Friends 2010, eircom Talktime Family 2010, eircom Talktime Friends After Hours, eircom Talktime International, eircom Talktime Mobile, eircom Talktime Talker, eircom Talktime UK, eircom Talktime Weekender, Circle of Friends and eircom Options (Gold, Silver or Bronze).

(effective from 05/11/14 to 31/10/15)

- 2 For the avoidance of doubt, the Consumer Voice Promotion is not available to customers of any eircom voice package other than those listed in Note 1 above.

- promotion -

Consumer Voice Promotion
(effective from 05/11/14 to 31/10/15)

eircom Price List (Amendment No 31) 2014

- promotion -

- 3 The promotion is not available to customers availing of any eircom voice and broadband bundle.
- 4 The Consumer Voice Promotion can only be applied to eligible accounts from 05/11/14 to 31/10/15.
- 5 The Consumer Voice Promotion can only be availed of once per customer in any 18 month period, regardless of which eircom voice package(s) the customer is on while availing of the promotion.
- 6 Customers who avail of the Consumer Voice Promotion will receive a credit of €5.00 inc. VAT / €4.07 ex. VAT each month against their bill for a period of 4 months from the date on which the Consumer Voice Promotion is first applied to the customer's account.
- 7 Where a customer who is availing of this promotion opts into a broadband bundle, the Consumer Voice Promotion will cease to be applied to the customer's bill.
- 8 Where a customer ceases the voice package with which this Consumer Voice Promotion is associated, the Consumer Voice Promotion may cease to be applied to the customer's bill.
- 9 Once this promotion has been removed from a customer's account it will not be possible to re-enter the promotion.
- 10 eircom reserve the right to withdraw this offer by giving relevant notice in accordance with normal requirements.
- 11 These terms and conditions will apply together with the terms and conditions governing the customer's use of their eircom voice package.

(effective from 05/11/14 to 31/10/15)

- promotion -

eTalk 2014 + eFibre Dual Play New and Winback Bundle Promotion

(effective from 05/11/14 to 31/10/15)

eircom Price List (Amendment No 31) 2014

- promotion -

eTalk 2014	<i>plus</i>	eFibre
eTalk (2014) Off-Peak <i>or</i> eTalk (2014) Anytime		eFibre Advanced <i>or</i> eFibre Advanced (Unlimited)

Number of Discount Instalments	Promotional Discount per Instalment		Total Promotional Discount	
	6	inc. VAT	€10.00	inc. VAT
ex Vat		€8.13	ex Vat	€48.78

Notes :

- 1 The eTalk (2014) + eFibre Dual Play New and Winback Bundle Promotion is made available to New and Winback customers for those customers who sign up between November 5th 2014 and October 31st 2015 inclusive and avail of an eTalk (2014) + eFibre Dual Play Bundle as outlined above.
- 2 Qualifying customers who avail of an eTalk (2014) + eFibre Dual Play New and Winback Bundle Promotion will receive a monthly discount on €10.00 (inc VAT)/ €8.13 (ex VAT) on their bill applicable to the first 6 months following sign up to the bundle.
- 3 Customers must remain on one of the eTalk (2014) and eFibre promotional bundles throughout the 6 month promotional period in order to avail of all 6 monthly instalments of promotional discount.
- 4 The promotion is made available subject to an 18 month contract term being applied to the bundle. For the avoidance of doubt, early cease charges will apply where either the eTalk (2014) or eFibre service is ceased within the minimum contract period.
- 5 Customers availing of the promotion who change any component (see component list in Part 4.1.9 of this price list) within the bundle (while retaining all components in the bundle) within the initial 6 months after availing of the promotion will continue to receive the bundle promotion for the outstanding term of the promotion only.
- 6 eircom reserves the right to withdraw this offer by giving relevant notice in accordance with normal requirements.
- 7 A customer may only avail of this promotion once.
- 8 These terms and conditions will apply together with the terms and conditions governing the customer's use of the components included in the bundle.
- 9 A customer may not avail of more than one eFibre Broadband Bundle Promotion simultaneously.

eTalk 2014	<i>plus</i>	NGB Broadband
eTalk (2014) Off-Peak <i>or</i> eTalk (2014) Anytime		NGB Advanced <i>or</i> NGB Advanced (Unlimited)

(effective from 05/11/14 to 31/10/15)

- promotion -

Number of Discount Instalments	Promotional Discount per Instalment		Total Promotional Discount	
	6	inc. VAT	€10.00	inc. VAT
ex Vat		€8.13	ex Vat	€48.78

Notes :

- 1 The eTalk (2014) + NGB Broadband Dual Play New and Winback Bundle Promotion is made available to New and Winback customers for those customers who sign up between November 5th 2014 and October 31st 2015 inclusive and avail of an eTalk (2014) + NGB Broadband Dual Play Bundle as outlined above.
- 2 Qualifying customers who avail of an eTalk (2014) + NGB Broadband Dual Play New and Winback Bundle Promotion will receive a monthly discount on €10.00 (inc VAT)/ €8.13(ex VAT) on their bill applicable to the first 6 months following sign up to the bundle.
- 3 Customers must remain on one of the eTalk (2014) and NGB Broadband promotional bundles throughout the 6 month promotional period in order to avail of all 6 monthly instalments of promotional discount.
- 4 The promotion is made available subject to a 18 month contract term being applied to the bundle. For the avoidance of doubt, early cease charges will apply where either the eTalk (2014) or NGB service is ceased within the minimum contract period.
- 5 Customers availing of the promotion who change any component (see component list in Part 4.1.9 of this price list) within the bundle (while retaining all components in the bundle) within the initial 6 months after availing of the promotion will continue to receive the bundle promotion for the outstanding term of the promotion only.
- 6 eircom reserves the right to withdraw this offer by giving relevant notice in accordance with normal requirements.
- 7 A customer may only avail of this promotion once.
- 8 These terms and conditions will apply together with the terms and conditions governing the customer's use of the components included in the bundle.
- 9 A customer may not avail of more than one NGB Broadband Bundle Promotion simultaneously.

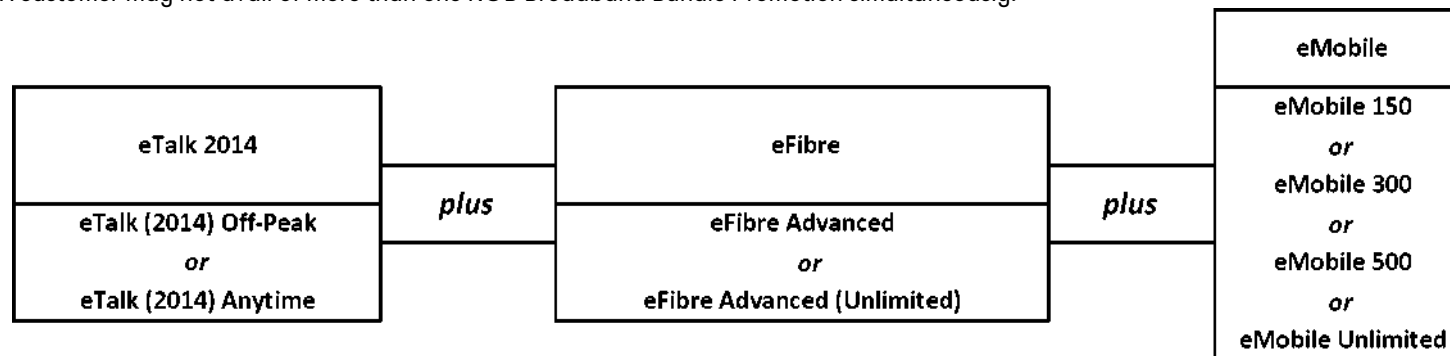

Number of Discount Instalments	Promotional Discount per Instalment		Total Promotional Discount	
	6	inc. VAT	€25.00	inc. VAT
ex Vat		€20.33	ex Vat	€121.98

(effective f

- promotion -

eTalk 2014, eFibre and eMobile Triple Play New and Winback Bundle Promotion

(effective from 05/11/14 to 31/10/15)

eircom Price List (Amendment No 31) 2014

- promotion -

Notes :

- 1 The eTalk (2014), eFibre and eMobile Triple Play New and Winback Bundle Promotion is made available to New and Winback customers for those customers who sign up between 5th November 2014 and 31st October 2015 inclusive and avail of an eTalk (2014), eFibre and eMobile Triple Bundle as outlined above.
- 2 Qualifying customers who avail of an eTalk (2014), eFibre and eMobile Triple Play New and Winback Bundle Promotion will receive a monthly discount on €25.00 (inc VAT)/ €20.33 (ex VAT) on their bill applicable to the first 6 months following sign up to the bundle.
- 3 Customers must remain on one of the eTalk (2014), eFibre and eMobile promotional bundles throughout the 6 month promotional period in order to avail of all 6 monthly instalments of promotional discount.
- 4 The promotion is made available subject to a 18 month contract term being applied to the bundle. For the avoidance of doubt, early cease charges will apply where any eTalk (2014), eFibre or eMobile service is ceased within the minimum contract period.
- 5 Customers availing of the promotion who change any component (see component list in Part 4.1.9 of this price list) within the bundle (while retaining all components in the bundle) within the initial 6 months after availing of the promotion will continue to receive the bundle promotion for the outstanding term of the promotion only.
- 6 eircom reserves the right to withdraw this offer by giving relevant notice in accordance with normal requirements.
- 7 A customer may only avail of this promotion once.
- 8 Customers availing of this promotion may not simultaneously avail of any other eFibre Bundle Promotion.
- 9 These terms and conditions will apply together with the terms and conditions governing the customer's use of the components included in the bundle.

(effective from 05/11/14 to 31/10/15)

- promotion -

eTalk 2014, NGB Broadband and eMobile Triple Play New and Winback Bundle Promotion

(effective from 05/11/14 to 31/10/15)

eircom Price List (Amendment No 31) 2014

eMobile

- promotion -

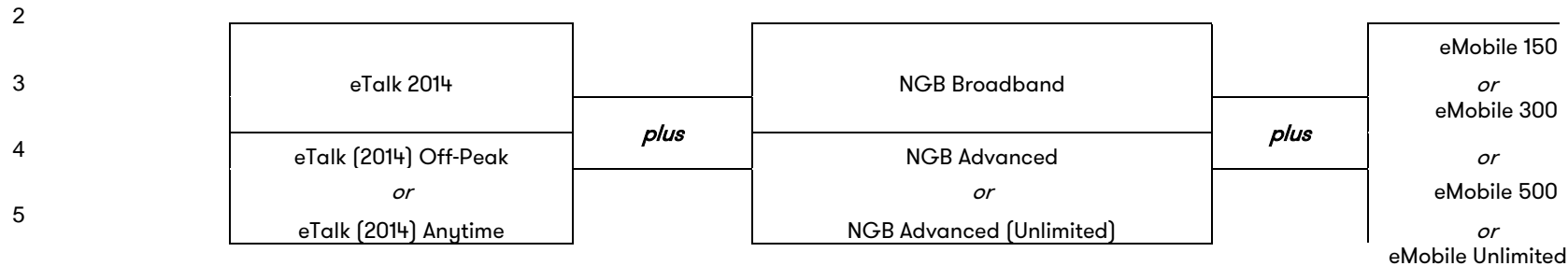

Number of Discount Instalments	Promotional Discount per Instalment		Total Promotional Discount	
	6	inc. VAT	€25.00	inc. VAT
	ex Vat	€20.33	ex Vat	€121.98

Notes :

¹ The eTalk (2014), NGB Broadband and eMobile Triple Play New and Winback Bundle Promotion is made available to New and Winback customers for those customers who sign up between 5th November 2014 and 31st October 2015 inclusive and avail of an eTalk (2014), NGB Broadband and eMobile Triple Play Bundle as outlined above.

Qualifying customers who avail of an eTalk (2014), NGB Broadband and eMobile Triple Play New and Winback Bundle Promotion will receive a monthly discount on €25.00 (inc VAT)/ €20.33 (ex VAT) on their bill applicable to the first 6 months following sign up to the bundle.

Customers must remain on one of the eTalk (2014), NGB Broadband and eMobile promotional bundles throughout the 6 month promotional period in order to avail of all 6 monthly instalments of promotional discount.

The promotion is made available subject to a 18 month contract term being applied to the bundle. For the avoidance of doubt, early cease charges will apply where any eTalk (2014), NGB Broadband or eMobile service is ceased within the minimum contract period.

Customers availing of the promotion who change any component (see component list in Part 4.1.9 of this price list) within the bundle (while retaining all components in the bundle) within the initial 6 months after availing of the promotion will continue to receive the bundle promotion for the outstanding term of the promotion only.

6 eircom reserves the right to withdraw this offer by giving relevant notice in accordance with normal requirements.

7 A customer may only avail of this promotion once.

8 Customers availing of this promotion may on an opt-in basis simultaneously avail of the discount of €15 (inc VAT) per month for 6 months that is applied by the applied by the eTalk (2014), NGB Broadband and eMobile Triple Play Bundle Promotion as outlined in the eircom Price List (Amendment No 3, 2014), but may not simultaneously avail of any other NGB Broadband Bundle Promotion.

9 These terms and conditions will apply together with the terms and conditions governing the customer's use of the components included in the bundle.

(effective from 05/11/14 to 31/10/15)

- promotion -

eTalk 2014, eFibre and eVision Triple Play New and Winback Bundle Promotion

(effective from 05/11/14 to 31/10/15)

eircom Price List (Amendment No 31) 2014

- promotion -

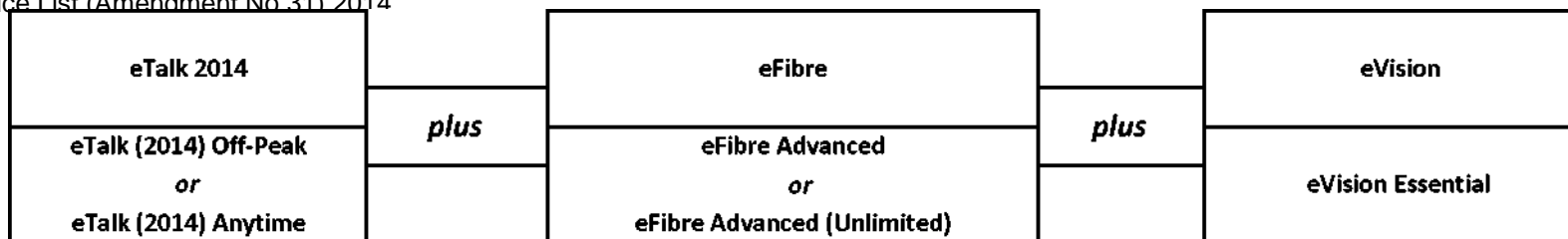

Number of Discount Instalments	Promotional Discount per Instalment		Total Promotional Discount	
	6	inc. VAT	€25.00	inc. VAT
ex Vat		€20.33	ex Vat	€121.98

Notes :

- 1 The eTalk (2014), eFibre and eVision Triple Play New and Winback Bundle Promotion is made available to New and Winback customers for those customers who sign up between 5th November 2014 and 31st October 2015 inclusive and avail of an eTalk (2014), eFibre and eVision Triple Play Bundle as outlined above.
- 2 Qualifying customers who avail of an eTalk (2014), eFibre and eVision Triple Play New and Winback Bundle Promotion will receive a monthly discount on €25.00 (inc VAT)/ €20.33 (ex VAT) on their bill applicable to the first 6 months following sign up to the bundle.
- 3 Customers must remain on one of the eTalk (2014), eFibre and eVision promotional bundles throughout the 6 month promotional period in order to avail of all 6 monthly instalments of promotional discount.
- 4 The promotion is made available subject to a 18 month contract term being applied to the bundle. For the avoidance of doubt, early cease charges will apply where any eTalk (2014), eFibre or eVision service is ceased within the minimum contract period.
- 5 Customers availing of the promotion who change any component (see component list in Part 4.1.9 of this price list) within the bundle (while retaining all components in the bundle) within the initial 6 months after availing of the promotion will continue to receive the bundle promotion for the outstanding term of the promotion only.
- 6 eircom reserves the right to withdraw this offer by giving relevant notice in accordance with normal requirements.
- 7 A customer may only avail of this promotion once.
- 8 Customers availing of this promotion may on an opt-in basis simultaneously avail of the discount of €10 (inc VAT) per month for 6 months that is applied by the applied by the eTalk (2014), eFibre and eVision Triple Play Bundle Promotion as outlined in the eircom Price List (Amendment No 3, 2014), but may not simultaneously avail of any other eFibre Bundle Promotion.
- 9 These terms and conditions will apply together with the terms and conditions governing the customer's use of the components included in the bundle.

(effective from 05/11/14 to 31/10/15)

- promotion -

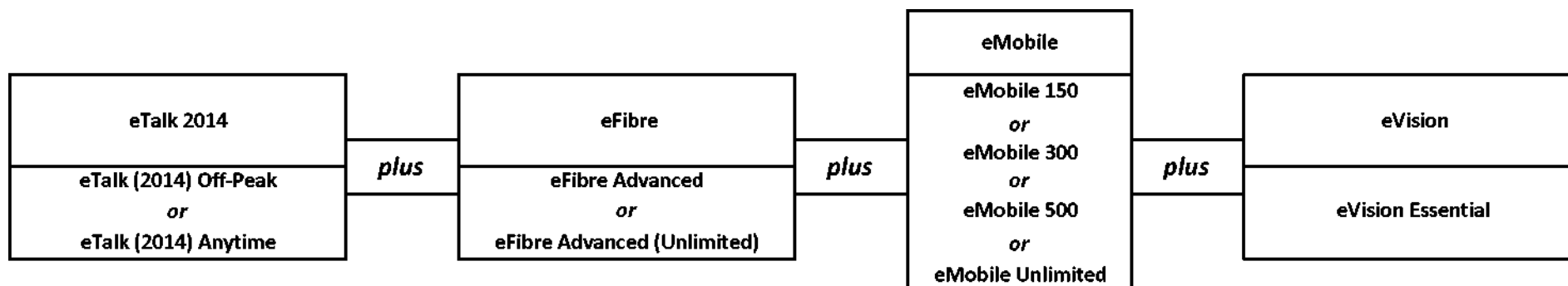

Number of Discount Instalments	Promotional Discount per Instalment		Total Promotional Discount	
	6	inc. VAT	€37.50	inc. VAT
ex Vat		€30.49	ex Vat	€182.94

Notes :

- 1 The eTalk (2014), eFibre, eMobile and eVision Quad Play New and Winback Bundle Promotion is made available to New and Winback customers for those customers who sign up between 5th November 2014 and 31st October 2015 inclusive and avail of an eTalk (2014), eFibre, eMobile and eVision Quad Play Bundle Promotion as outlined above.
- 2 Qualifying customers who avail of an eTalk (2014), eFibre, eMobile and eVision Quad Play New and Winback Bundle Promotion will receive a monthly discount on €37.50 (inc VAT)/ €30.49 (ex VAT) on their bill applicable to the first 6 months following sign up to the bundle.
- 3 Customers must remain on one of the eTalk (2014), eFibre, eMobile and eVision promotional bundles throughout the 6 month promotional period in order to avail of all 6 monthly instalments of promotional discount.
- 4 The promotion is made available subject to a 18 month contract term being applied to the bundle. For the avoidance of doubt, early cease charges will apply where any eTalk (2014), eFibre eMobile or eVision service is ceased within the minimum contract period.
- 5 Customers availing of the promotion who change any component (see component list in Part 4.1.9 of this price list) within the bundle (while retaining all components in the bundle) within the initial 6 months after availing of the promotion will continue to receive the bundle promotion for the outstanding term of the promotion only.
- 6 eircom reserves the right to withdraw this offer by giving relevant notice in accordance with normal requirements.
- 7 A customer may only avail of this promotion once.
- 8 Customers availing of this promotion may on an opt-in basis simultaneously avail of the discount of €10 (inc VAT) per month for 6 months that is applied by the applied by the eTalk (2014), eFibre, eMobile and eVision Quad Play Bundle Promotion as outlined in the eircom Price List (Amendment No 3, 2014), but may not simultaneously avail of any other eFibre Bundle Promotion.
- 9 These terms and conditions will apply together with the terms and conditions governing the customer's use of the components included in the bundle.

eircom Talk 2014	<i>plus</i>	Broadband
eircom Talk (2014) Off-Peak <i>or</i> eircom Talk (2014) Anytime		NGB Advanced <i>or</i> NGB Advanced (Unlimited)

Number of Discount Instalments	Promotional Discount per Instalment		Total Promotional Discount	
	6	inc. VAT	€10.00	inc. VAT
ex Vat		€8.13	ex Vat	€48.78

Notes :

- 1 The eircom Talk (2014) + NGB Broadband Dual Play New and Winback Bundle Promotion is made available to New and Winback customers for those customers who sign up between 5th November 2014 and 31st October 2015 inclusive and avail of an eircom Talk (2014) + NGB Broadband Dual Play Bundle as outlined above.
- 2 Qualifying customers who avail of an eircom Talk (2014) + NGB Broadband Dual Play New and Winback Bundle Promotion will receive a monthly discount on €10.00 (inc VAT)/ €8.13 (ex VAT) on their bill applicable to the first 6 months following sign up to the bundle.
- 3 Customers must remain on one of the eircom Talk (2014) and NGB Broadband promotional bundles throughout the 6 month promotional period in order to avail of all 6 monthly instalments of promotional discount.
- 4 The promotion is made available subject to a 18 month contract term being applied to the bundle. For the avoidance of doubt, early cease charges will apply where either the eircom Talk (2014) or NGB service is ceased within the minimum contract period.
- 5 Customers availing of the promotion who change any component (see component list in Part 4.1.9 of this price list) within the bundle (while retaining all components in the bundle) within the initial 6 months after availing of the promotion will continue to receive the bundle promotion for the outstanding term of the promotion only.
- 6 eircom reserves the right to withdraw this offer by giving relevant notice in accordance with normal requirements.
- 7 A customer may only avail of this promotion once.
- 8 These terms and conditions will apply together with the terms and conditions governing the customer's use of the components included in the bundle.
- 9 A customer may not avail of more than one NGB Broadband Bundle Promotion simultaneously.

eVision Premium Add On	Standard Monthly Rate		Promotional Price		Promo Duration
	ex. vat	inc. vat	ex. vat	inc. vat	Months
Setanta Sport + BT Sport Pack	€14.64	€18.00	€0.00	€0.00	2

Notes:

eircom Price List (Amendment No 38) 2014

Setanta Sport & BT Sport 2 Month Free Promotion

(promotional period : 1st January 2015 to 31st December 2015)

- 1 The following terms and conditions of the 2 month free Setanta Sport and BT Sport promotion (the "Promotion") apply together with the eVision terms and conditions ("eVision Terms") and the Premium Channel Pack terms and conditions ("Premium Channel Pack Terms") which can be found at https://www.eircom.net/assets/static/pdf/tv/evision_tv_terms.pdf and all constitute a legally binding agreement between eircom Limited ("eVision") and the eVision customer ("Customer").
- 2 The Promotion is available to all new eVision customers and existing eVision customers who have not signed up to a Setanta Sport and BT Sport Pack or existing eVision customers who signed up to a Setanta Sport and BT Sport Pack more than 12 months ago and who subsequently terminated same ("Eligible Customers").
 - 3 The Promotion can only be availed of by Eligible Customers from 1 January 2015 until 31 December 2015 or as otherwise notified by eVision.
- 4 In the event there are a number of promotions being offered by eVision at the same time for the Setanta Sport and BT Sport Pack an Eligible Customer can only avail of one promotion.
- 5 A Customer who avails of the Promotion will receive the first two months of Setanta Sport and BT Sport Pack for free from the Operational Service Date for the Setanta Sport and BT Sport Pack. Thereafter the Customer will be subject to the standard monthly charge for Setanta Sport and BT Sport Pack and shall pay same in accordance with the eVision Terms.terminates their subscription to the Setanta Sport and BT Sport Pack in accordance with clause eVision reserves the right to withdraw the Promotion by giving relevant notice to the Customer in accordance with the eVision Terms and the Premium Channel Pack Terms.
- 6 7 A Customer may terminate the Setanta Sport and BT Sport 2 Pack in accordance with the Premium Channel Pack Terms.
- 8 Where a Customer who is availing of this Promotion terminates their eVision service this Promotion will immediately cease to apply.
- 9 In the event of any conflict relating to the operation of the Promotion, the terms and conditions of the Promotion shall prevail. Terms not herein defined shall have the meaning ascribed to them in the eVision Terms and the Premium Channel Pack terms and conditions.

eircom Talktime for Business	PSTN Monthly Package Price		ISDN Monthly Package Price		Number of Peak, local & national call minutes (1)	Number of free Minutes to eMobile	Promotional Offer
	ex. Vat	inc. Vat	ex. Vat	inc. Vat			
	€33.26	€40.91	€44.81	€55.12	150	600	€7.50 per month for 12 months

eircom Value Business Multi-Line Plan Price	Monthly Subscription Fee		Number of Fixed local / national minutes per month	Number of minutes to Irish Mobile Operators per month	Number of free minutes to eMobile	Number of free minutes to UK Landlines	Promotional Monthly Offer
	ex. Vat	inc. Vat					
Value Business Plan-Multi-line 1	€31.00	€38.13	1,000	100	600	60	First Month FREE First Month FREE First Month FREE First Month FREE First Month FREE First Month FREE
Value Business Plan-Multi-line 2	€40.00	€49.20	400	200	600	60	
Value Business Plan-Multi-line 3	€74.00	€91.02	800	400	600	60	
Value Business Plan-Multi-line 4	€104.00	€127.92	1,500	500	600	120	
Value Business Plan-Multi-line 5	€124.00	€152.52	800	800	600	120	
Value Business Plan-Multi-line 6	€185.00	€227.55	1,500	1,200	600	120	

eircom Business Complete	PSTN Monthly Package Price		ISDN Monthly Package Price		Number of local & national call minutes per month	Number of minutes to Irish Mobile Operators per month	Promotional Credit
	ex. Vat	inc. Vat	ex. Vat	inc. Vat			
	€45.99	€56.57	€76.49	€92.85	2500	1500	First Month FREE

(see notes on next page)

Notes:

1. This Promotion is available to customers of the following eircom products and services (eircom Talktime for Business Level 1, eircom Multi-Line Business Plans and eircom Business Complete).
2. eircom may at its absolute discretion, without further notice to the Customer, withdraw the "Business Voice Plan Opt-In Contract promotion" from the Customer's telephone account.
3. Customers who avail of the Opt-In promotion must agree to a new 12 month contract being applied to their account.
4. In cases where the Customer is still on contract due to availing of the voice plan, the Opt-In promotion will replace this and a new 12 month contract will start.
5. This offer is to allow the Customer to avail of the Business Voice Plan Opt-In Contract promotion facility is only made available to those customers who sign up between 5th January 2015 to 31st December 2015.
6. This Agreement is terminable by the Customer giving notice to the Company. On termination of this Agreement by either party, all associated features of the Facility shall no longer apply to the Customer's account except for the Phone Services, unless expressly ceased by the Customer, the Phone Services shall remain on the Customer's exchange line and shall be charged for at standard rates. Where the Facility is terminated by the Customer in a Billing Cycle all calls charged for in that Billing Cycle in which the Facility is terminated by the Customer shall be charged for at standard rates.
7. These terms and conditions together with the customers current eircom voice plan terms and conditions for Business call charges (as specified in the eircom Price List), constitute the entire agreement between the parties in relation to the Facility.
8. The Customer shall be given thirty (30) days notice of any amendment to the Facility.
9. This Agreement is governed by the laws of Ireland.

Premium Add Ons	Normal Price		Promotional Price	
	ex vat	inc vat	ex vat	inc vat
Sky Sports	€24.39	€30.00	€12.20	€15.00
Sky Movies	€19.51	€24.00	€9.76	€12.00
Sky Sports & Movies	€32.52	€40.00	€16.26	€20.00
Setanta & BT	€14.63	€18.00	€7.32	€9.00

Notes:

- 1 The following terms and conditions of the Premium Add-On half price for 3 months promotion (the "Promotion") apply together with the eVision terms and conditions ("eVision Terms") and the Premium Channel Pack terms and conditions ("Premium Channel Pack Terms") which can be found at https://www.eircom.net/assets/static/pdf/tv/evision_tv_terms.pdf and all constitute a legally binding agreement between eircom Limited ("eVision") and the eVision customer ("Customer").
- 2 The Promotion is available to all new eVision customers and existing eVision customers who have not signed up to the chosen Premium Add-On Pack or existing eVision customers who signed up to the chosen Premium Add-On Pack more than 12 months ago and who subsequently terminated same ("Eligible Customers").
- 3 The Promotion can only be availed of by Eligible Customers from 15 January 2015 until 31 December 2015 or as otherwise notified by eircom.
- 4 In the event there are a number of promotions being offered at the same time for the chosen Premium Add-On Pack an Eligible Customer can only avail of one promotion.
 - 5 A Customer who avails of the Promotion will receive the first three (3) months of the chosen Premium Add-On Pack for half price from the Operational Service Date for the Premium Add-On Pack. Thereafter the Customer will be subject to the standard monthly charge for the chosen Premium Add-On Pack and shall pay same in accordance with the eVision Terms.

eVision reserves the right to withdraw the Promotion by giving relevant notice to the Customer in accordance with the eVision Terms and the Premium Channel Pack Terms.

- 7 A Customer may terminate the chosen Premium Add-On Pack in accordance with the Premium Channel Pack Terms.
- 8 Where a Customer who is availing of this Promotion terminates their eVision service this Promotion will immediately cease to apply.
- 9 In the event of any conflict relating to the operation of the Promotion, the terms and conditions of the Promotion shall prevail. Terms not herein defined shall have the meaning ascribed to them in the eVision Terms and the Premium Channel Pack terms and conditions.

eircom Talk + eircom Broadband Dual Play New and Winback Bundle Promotion

(effective from 01/08/14 to 31/07/15)

eircom Price List (Amendment No 4) 2015

- promotion -

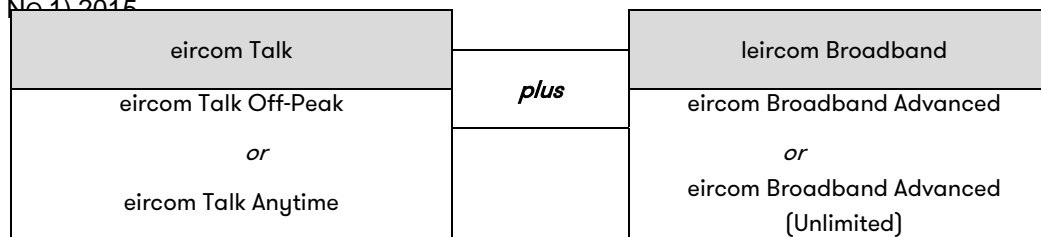

Number of Discount Instalments	Promotional Discount per Instalment		Total Promotional Discount	
	6	inc. VAT	€24.00	inc. VAT
ex Vat		€19.51	ex Vat	€117.07

Notes :

- 1 The eircom Talk + eircom Broadband Dual Play New and Winback Bundle Promotion is made available to New and Winback customers for those customers who sign up between 1st August 2014 and 31st July 2015 inclusive and avail of an eircom Talk + eircom Broadband Dual Play Bundle as outlined above.
- 2 Qualifying customers who avail of an eircom Talk + eircom Broadband Dual Play New and Winback Bundle Promotion will receive a monthly discount on €24.00 (inc VAT)/ €19.51 (ex VAT) on their bill applicable to the first 6 months following sign up to the bundle.
- 3 Customers must remain on one of the eircom Talk and eircom Broadband promotional bundles throughout the 6 month promotional period in order to avail of all 6 monthly instalments of promotional discount.
- 4 The promotion is made available subject to a 18 month contract term being applied to the bundle. For the avoidance of doubt, early cease charges will apply where either the eircom Talk or eircom Broadband service is ceased within the minimum contract period.
- 5 Customers availing of the promotion who change any component (see component list in Part 4.1.9 of this price list) within the bundle (while retaining all components in the bundle) within the initial 3 months after availing of the promotion will continue to receive the bundle promotion for the outstanding term of the promotion only.
- 6 eircom reserves the right to withdraw this offer by giving relevant notice in accordance with normal requirements.
- 7 A customer may only avail of this promotion once.
- 8 These terms and conditions will apply together with the terms and conditions governing the customer's use of the components included in the bundle.
- 9 A customer may not avail of more than one eircom Broadband Bundle Promotion simultaneously.

(effective from 15/01/15 to 31/7/15)

- promotion -

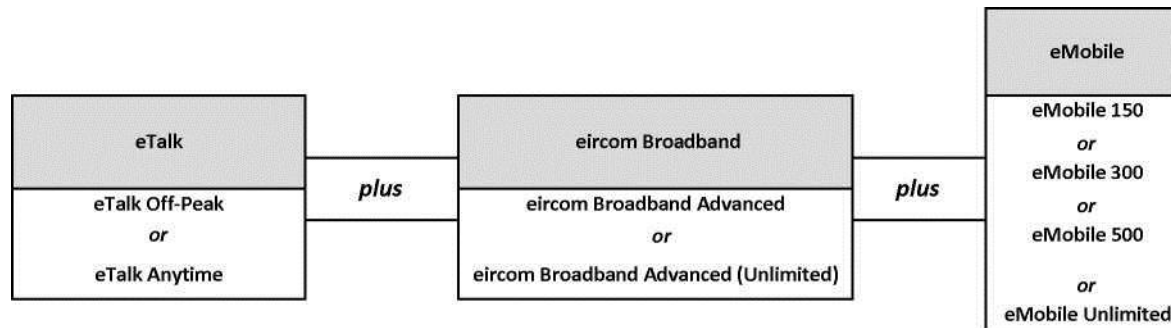

Number of Discount Instalments	Promotional Discount per Instalment		Total Promotional Discount	
	6	inc. VAT	€39.00	inc. VAT
ex Vat		€31.71	ex Vat	€190.24

Notes :

- 1 The eTalk, eircom Broadband and eMobile Triple Play New and Winback Bundle Promotion is made available to New and Winback customers for those customers who sign up between 1st August 2014 and 31st July 2015 inclusive and avail of an eTalk, eircom Broadband and eMobile Triple Play Bundle as outlined above.
- 2 Qualifying customers who avail of an eTalk, eircom Broadband and eMobile Triple Play New and Winback Bundle Promotion will receive a monthly discount on €39.00 (inc VAT)/ €31.71 (ex VAT) on their bill applicable to the first 6 months following sign up to the bundle.
- 3 Customers must remain on one of the eTalk, eircom Broadband and eMobile promotional bundles throughout the 6 month promotional period in order to avail of all 6 monthly instalments of promotional discount.
- 4 The promotion is made available subject to a 18 month contract term being applied to the bundle. For the avoidance of doubt, early cease charges will apply where any eTalk, eircom Broadband or eMobile service is ceased within the minimum contract period.
- 5 Customers availing of the promotion who change any component (see component list in Part 4.1.9 of this price list) within the bundle (while retaining all components in the bundle) within the initial 3 months after availing of the promotion will continue to receive the bundle promotion for the outstanding term of the promotion only.
- 6 eircom reserves the right to withdraw this offer by giving relevant notice in accordance with normal requirements.
- 7 A customer may only avail of this promotion once.
- 8 Customers may not simultaneously avail of any other Fibre Bundle Promotion.
- 9 These terms and conditions will apply together with the terms and conditions governing the customer's use of the components included in the bundle.

eircom Broadband (effective from 15/01/15 to 31/07/15) eircom Price List (Amendment NO 1) 2015	Number of Discount Instalments	Promotional Discount per Instalment		Total Promotional Discount	
	6	inc vat	ex. Vat	inc vat	ex. Vat
		€15.00	€12.20	€90.00	€73.20
	<i>or</i>			<i>or</i>	
	eMobile 300			eircom Broadband Solo Advanced	
	<i>or</i>			<i>or</i>	
	eMobile 500			eircom Broadband Solo Advanced Unlimited	
	<i>or</i>				
	eMobile Unlimited				

- promotion -

Notes:

- 1 The eircom Broadband and eMobile Dual Play Bundle Promotion is made available to existing customers who are new to the bundle and apply for the promotion between 3rd March 2014 and 31st July 2015.
- 2 Customers who avail of an eircom Broadband and eMobile Dual Play Bundle Promotion will receive a monthly discount of €15.00 (inc VAT)/ €12.20 (ex VAT) on their bill applicable to the first 6 months following sign up to the bundle.
- 3 Customers must remain on one of the eircom Broadband and eMobile promotional bundles throughout the 6 month promotional period in order to avail of all 6 monthly instalments of promotional discount.
- 4 The promotion is made available subject to a 18 mth contract term being applied to the bundle (24mth may apply depending on eMobile Handset chosen). For the avoidance of doubt, early cease charges will apply where either the NGB or eMobile service is ceased within the min contract period.
- 5 Customers availing of the promotion who change any component (see component list in Part 4.1.9 of this price list) within the bundle (while retaining all components in the bundle) within the initial 6 months after availing of the promotion will continue to receive the bundle promotion for the outstanding term of the promotion only. eircom reserves the right to withdraw this offer by giving relevant notice in accordance with normal requirements.
- 6 A customer may only avail of this promotion once.
- 7 These terms and conditions will apply together with the terms and conditions governing the customer's use of the components included in the bundle.
- 8 A customer may not avail of more than one eFibre Bundle Promotion simultaneously.
- 9

(effective from 15/01/15 to 31/07/15)

- promotion -

eTalk, eircom Broadband and eMobile Triple Play Bundle Promotion

(effective from 03/03/14 to 31/07/15)

eircom Price List (Amendment No. 1) 2015

- promotion -

Fixed Line	<i>plus</i>	eircom Broadband	<i>plus</i>	Mobile
eTalk Off Peak <i>or</i> eTalk Anytime		eircom Broadband Advanced <i>or</i> eircom Broadband Advanced Unlimited		eMobile 150 <i>or</i> eMobile 300 <i>or</i> eMobile 500 <i>or</i> eMobile Unlimited

Number of Discount Instalments	Promotional Discount per Instalment		Total Promotional Discount	
	inc vat	ex. Vat	inc vat	ex. Vat
6	€15.00	€12.20	€90.00	€73.20

Notes :

- 1 The eTalk, eircom Broadband and eMobile Triple Play Bundle Promotion is made available to existing customers who are new to the bundle and apply for the promotion between 3rd March 2014 and 31st July 2015.
- 2 Customers who avail of an eTalk, eircom Broadband and eMobile Triple Play Bundle Promotion will receive a monthly discount of €15.00 (inc VAT)/ €12.20 (ex VAT) on their bill applicable to the first 6 months following sign up to the bundle.
- 3 Customers must remain on one of the eTalk, eircom Broadband and eMobile Triple Play promotional bundles throughout the 6 month promotional period in order to avail of all 6 monthly instalments of promotional discount.
- 4 The promotion is made available subject to a 18 month contract term being applied to the bundle. For the avoidance of doubt, early cease charges will apply where either any eTalk, eircom Broadband or eMobile service is ceased within the minimum contract period.
- 5 Customers availing of the promotion who change any component (see component list in Part 4.1.9 of this price list) within the bundle (while retaining all components in the bundle) within the initial 6 months after availing of the promotion will continue to receive the bundle promotion for the outstanding term of the promotion only.
- 6 eircom reserves the right to withdraw this offer by giving relevant notice in accordance with normal requirements.
- 7 A customer may only avail of this promotion once.
- 8 These terms and conditions will apply together with the terms and conditions governing the customer's use of the components included in the bundle.
- 9 A customer may not avail of more than one eircom Broadband Bundle Promotion simultaneously.

Fixed Line	<i>plus</i>	eircom Broadband
eircom Talk Off Peak <i>or</i> eircom Talk Anytime		eircom Broadband Advanced <i>or</i> eircom Broadband Advanced Unlimited

(effective from

Number of Discount Instalments	Promotional Discount per Instalment		Total Promotional Discount	
	inc vat	ex. Vat	inc vat	ex. Vat
6	€15.00	€12.20	€90.00	€73.20

- promotion -

Notes :

eircom Price List (Amendment NO 1) 2015

- ~~eircom Broadband and eircom Talk Dual Play Bundle Promotion~~
(effective from 01/08/14 to 31/07/15)
- 1 The eircom Broadband and eircom Talk Dual Play Bundle Promotion are new to the bundle and apply for the promotion between 1st August 2014 and 31st July 2015.
 - 2 Customers who avail of an eircom Talk and eircom Broadband bundle promotion will receive a monthly discount of €15.00 (inc VAT)/ €12.20 (ex VAT) on their bill applicable to the first 6 months following sign up to the bundle.
 - 3 Customers must remain on one of the eircom Talk and eircom Broadband promotional bundles throughout the 6 month promotional period in order to avail of all 6 monthly instalments of promotional discount.
 - 4 The promotion is made available subject to a 12 month contract term being applied to the bundle. For the avoidance of doubt, early cease charges will apply where either the eircom Talk or eircom Broadband service is ceased within the minimum contract period.
 - 5 Customers availing of the promotion who change any component within the bundle (while retaining all components in the bundle) within the initial 6 months after availing of the promotion will continue to receive the bundle promotion for the outstanding term of the promotion only.
 - 6 eircom reserves the right to withdraw this offer by giving relevant notice in accordance with normal requirements.
 - 7 A customer may only avail of this promotion once.
 - 8 These terms and conditions will apply together with the terms and conditions governing the customer's use of the components included in the bundle.
 - 9 A customer may not avail of more than one eircom Broadband Bundle Promotion simultaneously.

eTalk 2014 + eircom Broadband Dual Play New and Winback Bundle Promotion**(effective from 05/11/14 to 31/10/15)**

eircom Price List (Amendment No 31) 2014

- promotion -

eTalk 2014	plus	eircom Broadband
eTalk (2014) Off-Peak		eircom Broadband Advanced
<i>or</i> eTalk (2014) Anytime		<i>or</i> eircom Broadband Advanced (Unlimited)

Number of Discount Instalments	Promotional Discount per Instalment		Total Promotional Discount	
	6	inc. VAT	€10.00	inc. VAT
	ex Vat	€8.13	ex Vat	€48.78

Notes :

- 1 The eTalk (2014) + eircom Broadband Dual Play New and Winback Bundle Promotion is made available to New and Winback customers for those customers who sign up between November 5th 2014 and October 31st 2015 inclusive and avail of an eTalk (2014) + eircom Broadband Dual Play Bundle as outlined above.
- 2 Qualifying customers who avail of an eTalk (2014) + eircom Broadband Dual Play New and Winback Bundle Promotion will receive a monthly discount on €10.00 (inc VAT)/ €8.13(ex VAT) on their bill applicable to the first 6 months following sign up to the bundle.
- 3 Customers must remain on one of the eTalk (2014) and eircom Broadband promotional bundles throughout the 6 month promotional period in order to avail of all 6 monthly instalments of promotional discount.
- 4 The promotion is made available subject to a 18 month contract term being applied to the bundle. For the avoidance of doubt, early cease charges will apply where either the eTalk (2014) or eircom Broadband service is ceased within the minimum contract period.
- 5 Customers availing of the promotion who change any component (see component list in Part 4.1.9 of this price list) within the bundle (while retaining all components in the bundle) within the initial 6 months after availing of the promotion will continue to receive the bundle promotion for the outstanding term of the promotion only.
- 6 eircom reserves the right to withdraw this offer by giving relevant notice in accordance with normal requirements.
- 7 A customer may only avail of this promotion once.
- 8 These terms and conditions will apply together with the terms and conditions governing the customer's use of the components included in the bundle.
- 9 A customer may not avail of more than one eircom Broadband Bundle Promotion simultaneously.

(effective from 05/11/14 to 31/10/15)

- promotion -

eTalk 2014, eircom Broadband and eMobile Triple Play New and Winback Bundle Promotion

(effective from 05/11/14 to 31/10/15)

eircom Price List (Amendment NO 1) 2015

The eTalk (2014), eircom Broadband and eMobile Triple Play New and Winback Bundle Promotion is made available to New and Winback customers for those customers who sign - promotion -

eMobile

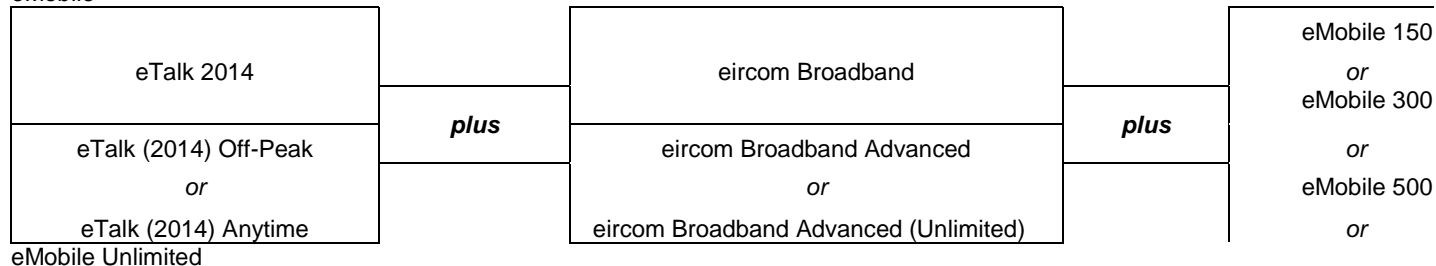

Number of Discount Instalments	Promotional Discount per Instalment		Total Promotional Discount	
	6	inc. VAT	€25.00	inc. VAT
ex Vat		€20.33	ex Vat	€121.98

Notes :

1

up between 5th November 2014 and 31st October 2015 inclusive and avail of an eTalk (2014), eircom Broadband and eMobile Triple Play Bundle as outlined above.

2 Qualifying customers who avail of an eTalk (2014), eircom Broadband and eMobile Triple Play New and Winback Bundle Promotion will receive a monthly discount on €25.00 (inc VAT)/ €20.33 (ex VAT) on their bill applicable to the first 6 months following sign up to the bundle.

3 Customers must remain on one of the eTalk (2014), eircom Broadband and eMobile promotional bundles throughout the 6 month promotional period in order to avail of all 6 monthly instalments of promotional discount.

4 The promotion is made available subject to a 18 month contract term being applied to the bundle. For the avoidance of doubt, early cease charges will apply where any eTalk (2014), eircom Broadband or eMobile service is ceased within the minimum contract period.

5 Customers availing of the promotion who change any component (see component list in Part 4.1.9 of this price list) within the bundle (while retaining all components in the bundle) within the initial 6 months after availing of the promotion will continue to receive the bundle promotion for the outstanding term of the promotion only.

6 eircom reserves the right to withdraw this offer by giving relevant notice in accordance with normal requirements.

7 A customer may only avail of this promotion once.

8 Customers availing of this promotion may on an opt-in basis simultaneously avail of the discount of €15 (inc VAT) per month for 6 months that is applied by the applied by the eTalk (2014), eircom Broadband and eMobile Triple Play Bundle Promotion as outlined in the eircom Price List (Amendment No 3, 2014), but may not simultaneously avail of any other eircom Broadband Bundle Promotion.

9 These terms and conditions will apply together with the terms and conditions governing the customer's use of the components included in the bundle.

(effective from 15/01/15 to 31/10/15)

- promotion -

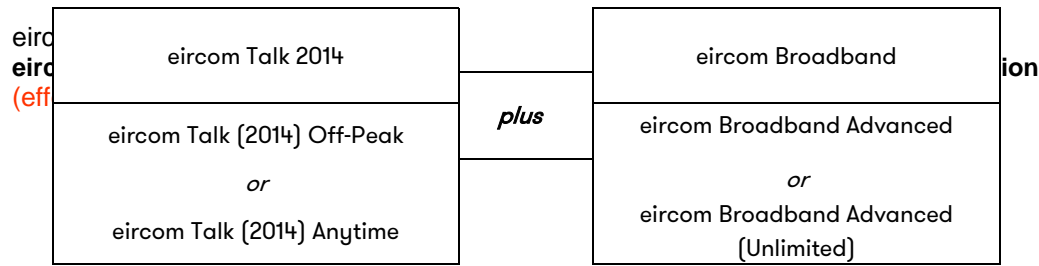

Number of Discount Instalments	Promotional Discount per Instalment		Total Promotional Discount	
	6	inc. VAT	€10.00	inc. VAT
ex Vat		€8.13	ex Vat	€48.78

Notes :

- 1 The eircom Talk (2014) + eircom Broadband Dual Play New and Winback Bundle Promotion is made available to New and Winback customers for those customers who sign up between 5th November 2014 and 31st October 2015 inclusive and avail of an eircom Talk (2014) + eircom Broadband Dual Play Bundle as outlined above.
- 2 Qualifying customers who avail of an eircom Talk (2014) + eircom Broadband Dual Play New and Winback Bundle Promotion will receive a monthly discount on €10.00 (inc VAT)/ €8.13 (ex VAT) on their bill applicable to the first 6 months following sign up to the bundle.
- 3 Customers must remain on one of the eircom Talk (2014) and eircom Broadband promotional bundles throughout the 6 month promotional period in order to avail of all 6 monthly instalments of promotional discount.
- 4 The promotion is made available subject to a 18 month contract term being applied to the bundle. For the avoidance of doubt, early cease charges will apply where either the eircom Talk (2014) or eircom service is ceased within the minimum contract period.
- 5 Customers availing of the promotion who change any component (see component list in Part 4.1.9 of this price list) within the bundle (while retaining all components in the bundle) within the initial 6 months after availing of the promotion will continue to receive the bundle promotion for the outstanding term of the promotion only.
- 6 eircom reserves the right to withdraw this offer by giving relevant notice in accordance with normal requirements.
- 7 A customer may only avail of this promotion once.
- 8 These terms and conditions will apply together with the terms and conditions governing the customer's use of the components included in the bundle.
- 9 A customer may not avail of more than one eircom Broadband Bundle Promotion simultaneously.

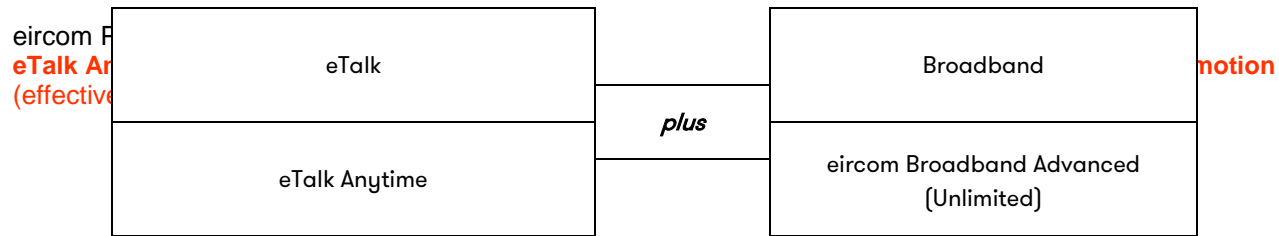

Number of Discount Instalments	Promotional Discount per Instalment		Total Promotional Discount	
	6	inc. VAT	€23.00	inc. VAT
ex Vat		€18.70	ex Vat	€112.20

- 1 The eTalk Anytime + eircom Broadband Advanced (Unlimited) Dual Play New and Winback Bundle Promotion is made available to new and winback customers for those customers who sign up between February 17th 2015 and June 30th 2015 inclusive and avail of an eTalk Anytime + eircom Broadband Advanced (Unlimited) Dual Play Bundle as outlined above.
- 2 Qualifying customers who avail of an eTalk Anytime + eircom Broadband Advanced (Unlimited) Dual Play New and Winback Bundle Promotion will receive a monthly discount of €23.00 (inc VAT)/ €18.70 (ex VAT) on their bill applicable to the first 6 months following sign up to the bundle.
- 3 Customers must remain on the eTalk Anytime + eircom Broadband Advanced (Unlimited) Dual Play bundle throughout the 6 month promotional period in order to avail of all 6 monthly instalments of promotional discount.
- 4 The promotion is made available subject to an 18 month contract term being applied to the bundle. For the avoidance of doubt, early cease charges will apply where either the eTalk or eircom Broadbnad service is ceased within the minimum contract period.
- 5 Customers availing of the promotion who change their eTalk or eircom Broadband service (see component list in Part 4.1.9 of this price list) will forfeit any outstanding instalments of discount.
- 6 eircom reserves the right to withdraw this offer by giving relevant notice in accordance with normal requirements.
- 7 A customer may only avail of this promotion once.
- 8 These terms and conditions will apply together with the terms and conditions governing the customer's use of the components included in the bundle.
- 9 A customer may not avail of more than one eircom Broadband Bundle Promotion simultaneously.

eTalk Anytime + eFibre Advanced (Unlimited) Dual Play New and Winback Bundle Promotion Broadband
 (effective from 17/02/15 to 30/06/15) *plus*

eircom Price List (Amendment No 4) 2015 eTalk Anytime

eFibre Advanced (Unlimited)

- promotion -

Number of Discount Instalments	Promotional Discount per Instalment		Total Promotional Discount	
	6	inc. VAT	€23.00	inc. VAT
ex Vat		€18.70	ex Vat	€112.20

- 1 The eTalk Anytime + eFibre Advanced (Unlimited) Dual Play New and Winback Bundle Promotion is made available to new and winback customers for those customers who sign up between February 17th 2015 and June 30th 2015 inclusive and avail of an eTalk Anytime + eFibre Advanced (Unlimited) Dual Play Bundle as outlined above.
- 2 Qualifying customers who avail of an eTalk Anytime + eFibre Advanced (Unlimited) Dual Play New and Winback Bundle Promotion will receive a monthly discount of €23.00 (inc VAT)/ €18.70 (ex VAT) on their bill applicable to the first 6 months following sign up to the bundle.
- 3 Customers must remain on the eTalk Anytime + eFibre Advanced (Unlimited) Dual Play bundle throughout the 6 month promotional period in order to avail of all 6 monthly instalments of promotional discount.
- 4 The promotion is made available subject to an 18 month contract term being applied to the bundle. For the avoidance of doubt, early cease charges will apply where either the eTalk or eFibre service is ceased within the minimum contract period.
- 5 Customers availing of the promotion who change their eTalk or eFibre service (see component list in Part 4.1.9 of this price list) will forfeit any outstanding instalments of discount.
- 6 eircom reserves the right to withdraw this offer by giving relevant notice in accordance with normal requirements.
- 7 A customer may only avail of this promotion once.
- 8 These terms and conditions will apply together with the terms and conditions governing the customer's use of the components included in the bundle.
- 9 A customer may not avail of more than one eFibre Bundle Promotion simultaneously.

(effective from 17/02/15 to 30/06/15)

- promotion -

eircom Talk Anytime + eircom Broadband Advanced (Unlimited) Dual Play New and Winback Bundle Promotion
 (effective from 17/02/15 to 30/06/15)

eircom Price List (Amendment NO 4) 2015

- promotion -

eircom T	eircom Talk		Broadband	
	Number of Discount Instalments	Promotional Discount per Instalment	Total Promotional Discount	
6	inc. VAT	€23.00	inc. VAT	€138.00
	ex Vat	€18.70	ex Vat	€112.20

- 1 The eircom Talk Anytime + eircom Broadband Advanced (Unlimited) Dual Play New and Winback Bundle Promotion is made available to new and winback customers for those customers who sign up between February 17th 2015 and June 30th 2015 inclusive and avail of an eircom Talk Anytime + eircom Broadband Advanced (Unlimited) Dual Play Bundle as outlined above.
- 2 Qualifying customers who avail of an eircom Talk Anytime + eircom Broadband Advanced (Unlimited) Dual Play New and Winback Bundle Promotion will receive a monthly discount of €23.00 (inc VAT)/ €18.70 (ex VAT) on their bill applicable to the first 6 months following sign up to the bundle.
- 3 Customers must remain on the eircom Talk Anytime + eircom Broadband Advanced (Unlimited) Dual Play bundle throughout the 6 month promotional period in order to avail of all 6 monthly instalments of promotional discount.
- 4 The promotion is made available subject to an 18 month contract term being applied to the bundle. For the avoidance of doubt, early cease charges will apply where either the eircom Talk or eircom Broadbnad service is ceased within the minimum contract period.
- 5 Customers availing of the promotion who change their eircom Talk or eircom Broadband service (see component list in Part 4.1.9 of this price list) will forfeit any outstanding instalments of discount.
- 6 eircom reserves the right to withdraw this offer by giving relevant notice in accordance with normal requirements.
- 7 A customer may only avail of this promotion once.
- 8 These terms and conditions will apply together with the terms and conditions governing the customer's use of the components included in the bundle.
- 9 A customer may not avail of more than one eircom Broadband Bundle Promotion simultaneously.

(effectibe from 17/02/15 to 30/06/15)

- promotion -

eTalk and eMobile Dual Play New and Winback Bundle Promotion

(effective from 17/02/15 to 30/06/15)

eireom Price List (Amendmenr NO 4) 2015

- promotion -

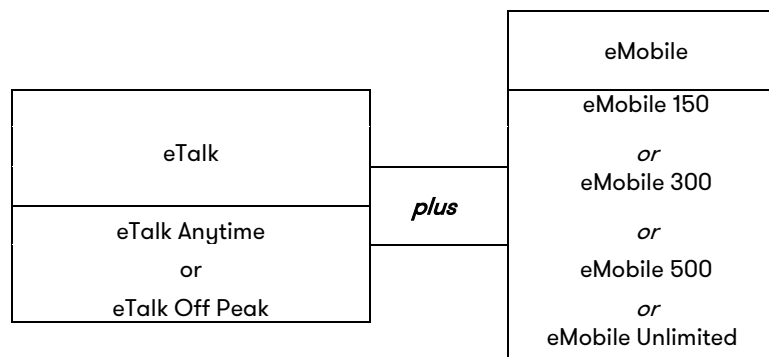

Number of Discount	Promotional Discount per Instalment		Total Promotional Discount	
	6	inc. VAT	€15.00	inc. VAT
ex Vat		€12.20	ex Vat	€73.17

- 1 The eTalk + eMobile Dual Play New and Winback Bundle Promotion is made available to new and winback customers for those customers who sign up between February 17th 2015 and June 30th 2015 inclusive and avail of an eTalk Anytime + eMobile Dual Play Bundle as outlined above.
- 2 Qualifying customers who avail of an eTalk + eMobile Dual Play New and Winback Bundle Promotion will receive a monthly discount of €15.00 (inc VAT)/ €12.20 (ex VAT) on their bill applicable to the first 6 months following sign up to the bundle.
- 3 Customers must remain on the eTalk + eMobile Dual Play bundle throughout the 6 month promotional period in order to avail of all 6 monthly instalments of promotional discount.
- 4 The promotion is made available subject to an 18 month contract term being applied to the bundle. For the avoidance of doubt, early cease charges will apply where either the eTalk or eMobile service is ceased within the minimum contract period.
- 5 Customers availing of the promotion who change any component (see component list in Part 4.1.9 of this price list) within the bundle (while retaining all components in the bundle) within the initial 6 months after availing of the promotion will continue to receive the bundle promotion for the outstanding term of the promotion only.
- 6 eircom reserves the right to withdraw this offer by giving relevant notice in accordance with normal requirements.
- 7 A customer may only avail of this promotion once.
- 8 These terms and conditions will apply together with the terms and conditions governing the customer's use of the components included in the bundle.
- 9 A customer may not avail of more than one eTalk Bundle Promotion simultaneously.

(effectvie from 17/02/15 to 30/06/15)

- promotion -

eFibre Advanced (Unlimited) and eMobile Dual Play New and Winback Bundle Promotion
 (effective from 17/02/15 to 30/06/15)

eircom Price List (Amendment No 4) 2015

- promotion -

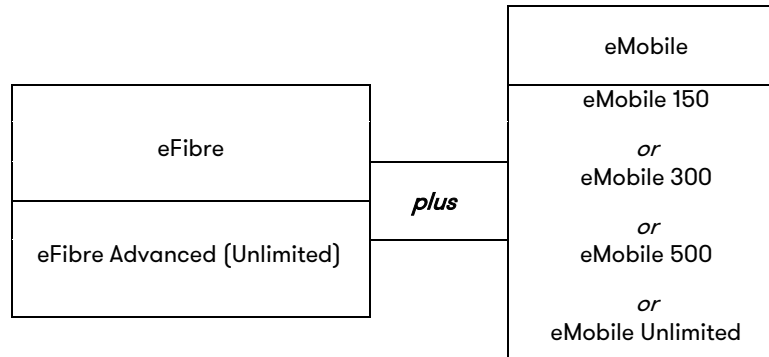

Number of Discount	Promotional Discount per Instalment		Total Promotional Discount	
	inc. VAT	€15.00	inc. VAT	€90.00
6	ex Vat	€12.20	ex Vat	€73.17

- 1 The eFibre Advanced (Unlimited) + eMobile Dual Play New and Winback Bundle Promotion is made available to new and winback customers for those customers who sign up between February 17th 2015 and June 30th 2015 inclusive and avail of an eFibre Advanced (Unlimited) + eMobile Dual Play Bundle as outlined above.
- 2 Qualifying customers who avail of an eFibre Advanced (Unlimited) + eMobile Dual Play New and Winback Bundle Promotion will receive a monthly discount of €15.00 (inc VAT)/ €12.20 (ex VAT) on their bill applicable to the first 6 months following sign up to the bundle.
- 3 Customers must remain on the eFibre Advanced (Unlimited) + eMobile Dual Play bundle throughout the 6 month promotional period in order to avail of all 6 monthly instalments of promotional discount.
- 4 The promotion is made available subject to an 18 month contract term being applied to the bundle. For the avoidance of doubt, early cease charges will apply where either the eFibre Advanced (Unlimited) or eMobile service is ceased within the minimum contract period.
- 5 Customers availing of the promotion who change any eMobile component (see component list in Part 4.1.9 of this price list) within the bundle (while retaining all components in the bundle) within the initial 6 months after availing of the promotion will continue to receive the bundle promotion for the outstanding term of the promotion only.
- 6 eircom reserves the right to withdraw this offer by giving relevant notice in accordance with normal requirements.
- 7 A customer may only avail of this promotion once.
- 8 These terms and conditions will apply together with the terms and conditions governing the customer's use of the components included in the bundle.
- 9 A customer may not avail of more than one eFibre Bundle Promotion simultaneously.

(effective from 17/02/15 to 30/06/15)

- promotion -

eircom Price List Broadband Adv (effective from 1	eircom Broadband Advanced (Unlimited)		plus		eMobile eMobile 150 or	
	Number of Discount	Promotional Discount per Instalment		Total Promotional Discount		
6		inc. VAT	€15.00	inc. VAT	€90.00	
	ex Vat	€12.20	ex Vat	€73.17		

k Bundle Promotion

- 1 The eircom Broadband Advanced (Unlimited) + eMobile Dual Play New and Winback Bundle Promotion is made available to new and winback customers for those customers who sign up between February 17th 2015 and June 30th 2015 inclusive and avail of an eircom Broadband Advanced (Unlimited) + eMobile Dual Play Bundle as outlined above.
- 2 Qualifying customers who avail of an eircom Broadband Advanced (Unlimited) + eMobile Dual Play New and Winback Bundle Promotion will receive a monthly discount of €15.00 (inc VAT)/ €12.20 (ex VAT) on their bill applicable to the first 6 months following sign up to the bundle.
- 3 Customers must remain on the eircom Broadband Advanced (Unlimited) + eMobile Dual Play bundle throughout the 6 month promotional period in order to avail of all 6 monthly instalments of promotional discount.
- 4 The promotion is made available subject to an 18 month contract term being applied to the bundle. For the avoidance of doubt, early cease charges will apply where either the eircom Broadband Advanced (Unlimited) or eMobile service is ceased within the minimum contract period.
- 5 Customers availing of the promotion who change any eMobile component (see component list in Part 4.1.9 of this price list) within the bundle (while retaining all components in the bundle) within the initial 6 months after availing of the promotion will continue to receive the bundle promotion for the outstanding term of the promotion only.
- 6 eircom reserves the right to withdraw this offer by giving relevant notice in accordance with normal requirements.
- 7 A customer may only avail of this promotion once.
- 8 These terms and conditions will apply together with the terms and conditions governing the customer's use of the components included in the bundle.
- 9 A customer may not avail of more than one eircom Broadband Bundle Promotion simultaneously.

eFibre Advanced (Unlimited) and eVision Dual Play New and Winback Bundle Promotion

(effective from 17/02/15 to 30/06/15)

eircom Price List (Amendment No 4) 2015

- promotion -

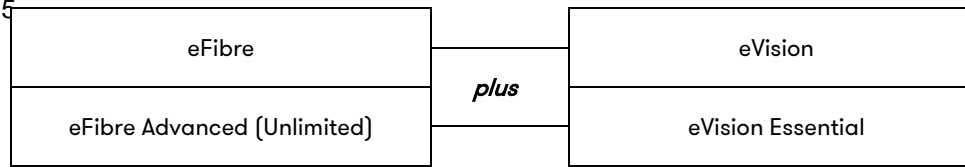

Number of Discount Instalments	Promotional Discount per Instalment		Total Promotional Discount	
	inc. VAT	€15.00	inc. VAT	€90.00
6	ex Vat	€12.20	ex Vat	€73.17

- 1 The eFibre Advanced (Unlimited) + eVision Dual Play New and Winback Bundle Promotion is made available to new and winback customers for those customers who sign up between February 17th 2015 and June 30th 2015 inclusive and avail of an eFibre Advanced (Unlimited) + eVision Dual Play Bundle as outlined above.
- 2 Qualifying customers who avail of an eFibre Advanced (Unlimited) + eVision Dual Play New and Winback Bundle Promotion will receive a monthly discount of €15.00 (inc VAT)/ €12.20 (ex VAT) on their bill applicable to the first 6 months following sign up to the bundle.
- 3 Customers must remain on the eFibre Advanced (Unlimited) + eVision Dual Play bundle throughout the 6 month promotional period in order to avail of all 6 monthly instalments of promotional discount.
- 4 The promotion is made available subject to an 18 month contract term being applied to the bundle. For the avoidance of doubt, early cease charges will apply where either the eFibre Advanced (Unlimited) or eVision service is ceased within the minimum contract period.
- 5 eircom reserves the right to withdraw this offer by giving relevant notice in accordance with normal requirements.
- 6 A customer may only avail of this promotion once.
- 7 These terms and conditions will apply together with the terms and conditions governing the customer's use of the components included in the bundle.
- 8 A customer may not avail of more than one eFibre Bundle Promotion simultaneously.

(effective from 17/02/15 to 30/06/15)

- promotion -

eFibre Advanced (Unlimited) / eircom Broadband Solo Advanced (Unlimited) New and Winback Promotion
 eireom Price List (amendment No 4) 2015 (effective from 17/02/15 to 30/06/15)

- promotion -

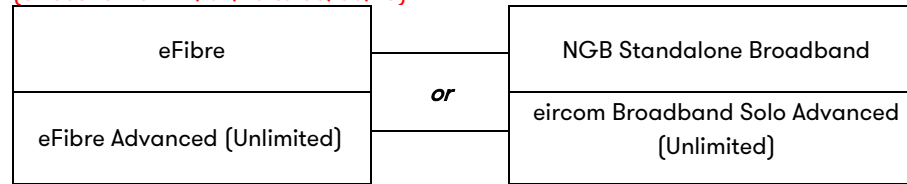

Number of Discount	Promotional Discount per Instalment		Total Promotional Discount	
	6	inc. VAT	€15.00	inc. VAT
ex Vat		€12.20	ex Vat	€73.17

Notes :

- 1 The eFibre Advanced (Unlimited) / eircom Broadband Solo Advanced (Unlimited) New and Winback Promotion is made available to new and winback customers for those customers who sign up between February 17th 2015 and June 30th 2015 inclusive and avail of standalone eFibre Advanced (Unlimited) or eircom Broadband Solo Advanced (Unlimited) as outlined above.
- 2 Qualifying customers who avail of eFibre Advanced (Unlimited) / eircom Broadband Solo Advanced (Unlimited) New and Winback Bundle Promotion will receive a monthly discount of €15.00 (inc VAT)/ €12.20 (ex VAT) on their bill applicable to the first 6 months following sign up to the bundle.
- 3 Customers must remain on the eFibre Advanced (Unlimited) or eircom Broadband Solo Advanced (Unlimited) service throughout the 6 month promotional period in order to avail of all 6 monthly instalments of promotional discount.
- 4 The promotion is made available subject to an 18 month contract term being applied to the eFibre Advanced (Unlimited) or eircom Broadband Solo Advanced (Unlimited) service. For the avoidance of doubt, early cease charges will apply where the eFibre Advanced (Unlimited) or eircom Broadband Solo Advanced (Unlimited) service is ceased within the minimum contract period.
- 5 Customers availing of the promotion who cease or change their eFibre or NGB Standalone Broadband service (see component list in Part 4.1.9 of this price list) will forfeit any outstanding instalments of discount.
- 6 eircom reserves the right to withdraw this offer by giving relevant notice in accordance with normal requirements.
- 7 A customer may only avail of this promotion once.
- 8 These terms and conditions will apply together with the terms and conditions governing the customer's use of the eFibre or NGB Standalone Broadband service.
- 9 A customer may not avail of more than one eFibre or NGB Standalone Broadband Promotion simultaneously.

eTalk, eFibre and eMobile Triple Play New and Winback Bundle Promotion
(effective from 17/02/15 to 30/06/15)

Option 1

eircom Price List (Amendment No 4) 2015

Option 1

- promotion -

eTalk	Broadband	eMobile	Discount (inc VAT)	Discount (ex VAT)
eTalk Off-Peak	eFibre Advanced or eircom Broadband Advanced	eMobile 150 or eMobile 300 or eMobile 500 or eMobile Unlimited	€15	12.20

Option 1

eTalk	Broadband	eMobile	Discount (inc VAT)	Discount (ex VAT)
eTalk Anytime	eFibre Advanced or eircom Broadband Advanced	eMobile 150 or eMobile 300 or eMobile 500 or eMobile Unlimited	€15	12.20

eTalk	Broadband	eMobile	Discount (inc VAT)	Discount (ex VAT)
eTalk Off-Peak	eFibre Advanced (Unlimited) or eircom Broadband Advanced (Unlimited)	eMobile 150 or eMobile 300 or eMobile 500 or eMobile Unlimited	€15	12.20

Option 2

eTalk	Broadband	eMobile	Discount (inc VAT)	Discount (ex VAT)
eTalk Anytime	eFibre Advanced or eircom Broadband Advanced (Unlimited)	eMobile 150 or eMobile 300 or eMobile 500 or eMobile Unlimited	€38	30.89

	Number of Discount Instalments	Promotional Discount per Instalment		Total Promotional Discount	
		inc. VAT	ex Vat	inc. VAT	ex Vat
Option 1	6	inc. VAT	€15.00	inc. VAT	€90.00
		ex Vat	€12.20	ex Vat	€73.17
Option 2	6	inc. VAT	€38.00	inc. VAT	€228.00
		ex Vat	€30.89	ex Vat	€185.37

(see notes on next page)
(effective from 17/02/15 to 30/06/15)

- promotion -

1. The eTalk, eFibre and eMobile Triple Play New and Winback Bundle Promotion is made available to new and winback customers for those customers who sign up between February 17th 2015 and June 30th 2015 inclusive and avail of an eTalk, eFibre and eMobile Triple Play Bundle as outlined above.
2. Qualifying customers who avail of an eTalk, eFibre and eMobile Triple Play New and Winback Bundle Promotion will receive a monthly discount on their bill applicable to the first 6 months following sign up to the bundle.
3. The value of the discount will be as shown in the table above. The applicable discount option will be determined by the eTalk, Broadband and eMobile services selected by the customer as outlined.
4. Customers must remain on the eTalk, eFibre and eMobile Triple Play bundle and retain the eTalk, Broadband and eMobile services required for the selected discount Option throughout the 6 month promotional period in order to avail of all 6 monthly instalments of promotional discount.
5. The promotion is made available subject to an 18 month contract term being applied to the bundle. For the avoidance of doubt, early cease charges will apply where eTalk, Broadband or eMobile service is ceased within the minimum contract period.
6. Customers availing of the promotion who change any eTalk, Broadband or eMobile component within the bundle (while retaining all components required for the selected discount Option) within the initial 6 months after availing of the promotion will continue to receive the bundle promotion for the outstanding term of the promotion only.
7. eircom reserves the right to withdraw this offer by giving relevant notice in accordance with normal requirements.
8. A customer may only avail of this promotion once.
9. These terms and conditions will apply together with the terms and conditions governing the customer's use of the components included in the bundle.
10. A customer may not avail of more than one eTalk Bundle Promotion simultaneously.

eircom Talk, eFibre and eMobile Triple Play New and Winback Bundle Promotion
 (effective from 17/02/15 to 30/06/15)

Option 1

eireom Price List (Amendment NO 4) 2015

Option 1

- promotion -

eircom Talk	Broadband	eMobile	Discount (inc VAT)	Discount (ex VAT)
eircom Talk Off-Peak	eircom Broadband Advanced	eMobile 150 or eMobile 300 or eMobile 500 or eMobile Unlimited	€15	12.20

eircom Talk	Broadband	eMobile	Discount (inc VAT)	Discount (ex VAT)
eircom Talk Off-Peak	eircom Broadband Advanced (Unlimited)	eMobile 150 or eMobile 300 or eMobile 500 or eMobile Unlimited	€15	12.20

Option 1

eircom Talk	Broadband	eMobile	Discount (inc VAT)	Discount (ex VAT)
eircom Talk Anytime	eircom Broadband Advanced	eMobile 150 or eMobile 300 or eMobile 500 or eMobile Unlimited	€15	12.20

eircom Talk	Broadband	eMobile	Discount (inc VAT)	Discount (ex VAT)
eircom Talk Anytime	eircom Broadband Advanced (Unlimited)	eMobile 150 or eMobile 300 or eMobile 500 or eMobile Unlimited	€38	30.89

	Number of Discount Instalments		Promotional Discount per Instalment	Total Promotional Discount
Option 1	6	inc. VAT	€15.00	€90.00
		ex Vat	€12.20	€73.17
Option 2	6	inc. VAT	€38.00	€228.00
		ex Vat	€30.89	€185.37

1. The eircom Talk, eFibre and eMobile Triple Play New and Winback Bundle Promotion is made available to new and winback customers for those customers who sign up between February 17th 2015 and June 30th 2015 inclusive and avail of an eircom Talk, eFibre and eMobile Triple Play Bundle as outlined above.
2. Qualifying customers who avail of an eircom Talk, eFibre and eMobile Triple Play New and Winback Bundle Promotion will receive a monthly discount on their bill applicable to the first 6 months following sign up to the bundle.
3. The value of the discount will be as shown in the table above. The applicable discount option will be determined by the eircom Talk, Broadband and eMobile services selected by the customer as outlined.
4. Customers must remain on the eircom Talk, eFibre and eMobile Triple Play bundle and retain the eircom Talk, Broadband and eMobile services required for the the selected discount Option throughout the 6 month promotional period in order to avail of all 6 monthly instalments of promotional discount.
5. The promotion is made available subject to an 18 month contract term being applied to the bundle. For the avoidance of doubt, early cease charges will apply where eircom Talk, Broadband or eMobile service is ceased within the minimum contract period.
6. Customers availing of the promotion who change any eircom Talk, Broadband or eMobile component within the bundle (while retaining all components required for the selected discount Option) within the initial 6 months after availing of the promotion will continue to receive the bundle promotion for the outstanding term of the promotion only.
7. eircom reserves the right to withdraw this offer by giving relevant notice in accordance with normal requirements.
8. A customer may only avail of this promotion once.
9. These terms and conditions will apply together with the terms and conditions governing the customer's use of the components included in the bundle.

eTalk Anytime, eFibre Advanced (Unlimited) + eVision Triple Play New and Winback Bundle Promotion

(effective from 17/02/15 to 30/06/15)

eircom Price List (Amendment No 4) 2015

- promotion -

10. A customer may not avail of more than one eircom Talk Bundle Promotion simultaneously.

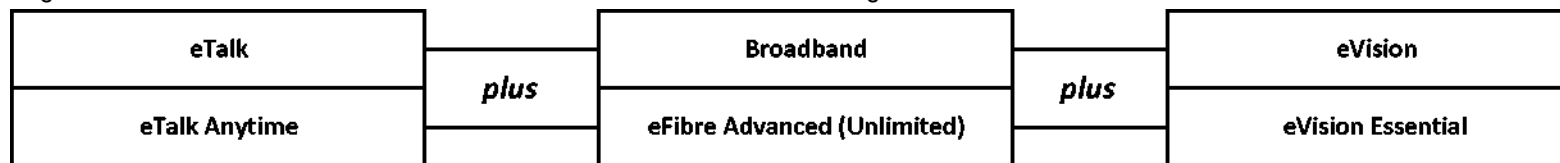

Number of Discount Instalments	Promotional Discount per Instalment		Total Promotional Discount	
	6	inc. VAT	€38.00	inc. VAT
ex Vat		€30.89	ex Vat	€185.37

- 1 The eTalk Anytime, eFibre Advanced (Unlimited) + eVision Triple Play New and Winback Bundle Promotion is made available to new and winback customers for those customers who sign up between February 17th 2015 and June 30th 2015 inclusive and avail of an eTalk Anytime, eFibre Advanced (Unlimited) + eVision Triple Play Bundle as outlined above.
- 2 Qualifying customers who avail of aneTalk Anytime, eFibre Advanced (Unlimited) + eVision Triple Play New and Winback Bundle Promotion will receive a monthly discount of €38.00 (inc VAT)/ €30.89 (ex VAT) on their bill applicable to the first 6 months following sign up to the bundle.
- 3 Customers must remain on theeTalk Anytime, eFibre Advanced (Unlimited) + eVision Triple Play bundle throughout the 6 month promotional period in order to avail of all 6 monthly instalments of promotional discount.
- 4 The promotion is made available subject to an 18 month contract term being applied to the bundle. For the avoidance of doubt, early cease charges will apply where either the eTalk or eFibre service is ceased within the minimum contract period.
- 5 Customers availing of the promotion who change their eTalk or eFibre service (see component list in Part 4.1.9 of this price list) will forfeit any outstanding instalments of discount.
- 6 eircom reserves the right to withdraw this offer by giving relevant notice in accordance with normal requirements.
- 7 A customer may only avail of this promotion once.
- 8 These terms and conditions will apply together with the terms and conditions governing the customer's use of the components included in the bundle.
- 9 A customer may not avail of more than one eFibre Bundle Promotion simultaneously.

(effective from 17/02/15 to 30/06/15)

- promotion -

eMobile, eFibre Advanced (Unlimited) + eVision Triple Play New and Winback Bundle Promotion

(effective from 17/02/15 to 30/06/15)

eireom Price List (Amendment No 4) 2015

- promotion -

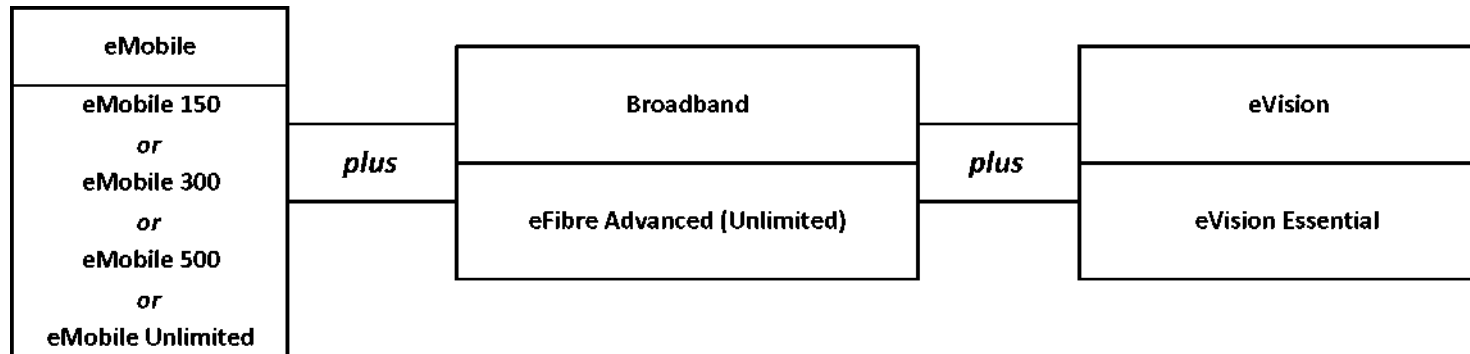

Number of Discount Instalments	Promotional Discount per Instalment		Total Promotional Discount	
	6	inc. VAT	€15.00	inc. VAT
ex Vat		€12.20	ex Vat	€73.17

- 1 The eMobile, eFibre Advanced (Unlimited) + eVision Triple Play New and Winback Bundle Promotion is made available to new and winback customers for those customers who sign up between February 17th 2015 and June 30th 2015 inclusive and avail of an eMobile, eFibre Advanced (Unlimited) + eVision Triple Play Bundle as outlined above.
- 2 Qualifying customers who avail of aneMobile, eFibre Advanced (Unlimited) + eVision Triple Play New and Winback Bundle Promotion will receive a monthly discount of €15.00 (inc VAT)/ €12.20 (ex VAT) on their bill applicable to the first 6 months following sign up to the bundle.
- 3 Customers must remain on the eMobile, eFibre Advanced (Unlimited) + eVision Triple Play bundle throughout the 6 month promotional period in order to avail of all 6 monthly instalments of promotional discount.
- 4 The promotion is made available subject to an 18 month contract term being applied to the bundle. For the avoidance of doubt, early cease charges will apply where either the eTalk or eFibre service is ceased within the minimum contract period.
- 5 Customers availing of the promotion who change their eFibre service (see component list in Part 4.1.9 of this price list) will forfeit any outstanding instalments of discount.
- 6 eircom reserves the right to withdraw this offer by giving relevant notice in accordance with normal requirements.
- 7 A customer may only avail of this promotion once.
- 8 These terms and conditions will apply together with the terms and conditions governing the customer's use of the components included in the bundle.
- 9 A customer may not avail of more than one eFibre Bundle Promotion simultaneously.

(effective from 17/02/15 to 30/06/15)

- promotion -

eTalk, eFibre, eMobile and eVision Quad Play New and Winback Bundle Promotion

(effective from 17/02/15 to 30/06/15)

Option 1

eireom Price List (Amendment No 4) 2015

Option 1

- promotion -

eircom Talk / eTalk	Broadband	eMobile	Discount (inc VAT)	Discount (ex VAT)
eircom Talk Off-Peak	eFibre Advanced	eMobile 150	€15	€12.20
or	or	or		
eTalk Off-Peak	eircom Broadband Advanced	eMobile 300		
		eMobile 500		
	eVision Essential	eMobile Unlimited		

eircom Talk / eTalk	Broadband	eMobile	Discount (inc VAT)	Discount (ex VAT)
eircom Talk Off-Peak	eFibre Advanced (Unlimited)	eMobile 150	€15	€12.20
or	or	or		
eTalk Off-Peak	eircom Broadband Advanced	eMobile 300		
		eMobile 500		
	eVision Essential	eMobile Unlimited		

Option 1

eircom Talk / eTalk	Broadband	eMobile	Discount (inc VAT)	Discount (ex VAT)
eircom Talk Anytime	eFibre Advanced	eMobile 150	€15	€12.20
or	or	or		
eTalk Anytime	eircom Broadband Advanced	eMobile 300		
		eMobile 500		
	eVision Essential	eMobile Unlimited		

Option 2

eircom Talk / eTalk	Broadband	eMobile	Discount (inc VAT)	Discount (ex VAT)
eircom Talk Anytime	eFibre Advanced (Unlimited)	eMobile 150	€50	€40.65
or	or	or		
eTalk Anytime	eircom Broadband Advanced	eMobile 300		
		eMobile 500		
	eVision Essential	eMobile Unlimited		

eVision Essential

eVision Essential

(see next page)

(effective from 17/02/15 to 30/06/15)

- promotion -

	Number of Discount Instalments		Promotional Discount per Instalment	Total Promotional Discount
Option 1	6	inc. VAT	€15.00	€90.00
		ex Vat	€12.20	€73.17
Option 2	6	inc. VAT	€50.00	€300.00
		ex Vat	€40.65	€243.90

1. The eTalk, eFibre, eMobile and eVision Quad Play New and Winback Bundle Promotion is made available to new and winback customers for those customers who sign up between February 17th 2015 and June 30th 2015 inclusive and avail of an eTalk, eFibre, eMobile and eVision Quad Play Bundle as outlined above.
2. Qualifying customers who avail of an eTalk, eFibre, eMobile and eVision Quad Play New and Winback Bundle Promotion will receive a monthly discount on their bill applicable to the first 6 months following sign up to the bundle.
3. The value of the discount will be as shown in the table above. The applicable discount option will be determined by the eTalk, Broadband, eMobile and eVision services selected by the customer as outlined.
4. Customers must remain on the eTalk, eFibre, eMobile and eVision Quad Play bundle and retain the eTalk, Broadband, eMobile and eVision services required for the the selected discount Option throughout the 6 month promotional period in order to avail of all 6 monthly instalments of promotional discount.
5. The promotion is made available subject to an 18 month contract term being applied to the bundle. For the avoidance of doubt, early cease charges will apply where eTalk, Broadband, eMobile or eVision service is ceased within the minimum contract period.
6. Customers availing of the promotion who change any eTalk, Broadband or eMobile component within the bundle (while retaining all components required for the selected discount Option) within the initial 6 months after availing of the promotion will continue to receive the bundle promotion for the outstanding term of the promotion only.
7. eircom reserves the right to withdraw this offer by giving relevant notice in accordance with normal requirements.
8. A customer may only avail of this promotion once.
9. These terms and conditions will apply together with the terms and conditions governing the customer's use of the components included in the bundle.
10. A customer may not avail of more than one eFibre Bundle Promotion simultaneously.

Online Additional 6 x €10 New and Winback Bundle Promotion

(effective from 17/02/15 to 30/06/15)

eircom Price List (Amendment No 4) 2015

- promotion -

Bundle Combo 1

eTalk	Broadband
eTalk Anytime	eFibre Advanced (Unlimited)
	or
	eircom Broadband Advanced (Unlimited)

Bundle Combo 2

eTalk	Broadband	eMobile
eTalk Anytime	eFibre Advanced (Unlimited)	eMobile 150
	or	or
	eircom Broadband Advanced	eMobile 300
		or
		eMobile 500
		or
		eMobile Unlimited

Bundle Combo 3

eTalk	Broadband
eTalk Anytime	eFibre Advanced (Unlimited)
	eVision Essential

Bundle Combo 4

eTalk	Broadband	eMobile
eTalk Anytime	eFibre Advanced (Unlimited)	eMobile 150
		or
		eMobile 300
		or
		eMobile 500
		or
		eMobile Unlimited
eVision Essential		

Number of Discount Instalments	Promotional Discount per Instalment		Total Promotional Discount	
	6	inc. VAT	€10.00	inc. VAT
ex Vat		€8.13	ex Vat	€48.78

(see notes on next page)

(effective from 17/02/15 to 30/06/15)

- promotion -

- 1 The Online Additional 6 x €10 New and Winback Bundle Promotion is made available to new and winback customers for those customers who sign up online between February 17th 2015 and June 30th 2015 inclusive and avail one of the multi-product bundle combinations outlined above.
- 2 Qualifying customers will receive a monthly discount of €10.00 (inc VAT)/ €8.13 (ex VAT) on their bill applicable to the first 6 months following sign up to the bundle.
- 3 Customers must remain on active on all elements of their chosen bundle combination throughout the 6 month promotional period in order to avail of all 6 monthly instalments of promotional discount.
- 4 The promotion is made available subject to an 18 month contract term being applied to the chosen bundle. For the avoidance of doubt, early cease charges will apply where any eTalk, Broadband, eMobile or eVision service is ceased within the minimum contract period.
- 5 Customers availing of the promotion who change any eTalk, Broadband or eMobile component within the bundle (while retaining all components required for the selected bundle combo promotion) within the initial 6 months after availing of the promotion will continue to receive the bundle promotion for the outstanding term of the promotion only.
- 6 eircom reserves the right to withdraw this offer by giving relevant notice in accordance with normal requirements.
- 7 A customer may only avail of this promotion once.
- 8 These terms and conditions will apply together with the terms and conditions governing the customer's use of the components included in the bundle.
- 9 A customer may avail of this promotion in addition to any other "New and Winback" promotion available with their chosen bundle.
- 10 Except as noted in clause 9 above, a customer may not avail of more than one eTalk bundle simultaneously.

eircom Business Broadband Bundle Promotion (promotional period from 5th March 2015 to 31st August 2015)

Dual Play Bundles	Monthly Upload / Download	Monthly Discount (ex vat)	Total Promotional Discount
eircom Business Advantage	50Gb	€24.79	€24.79
eircom Business Advantage Boost	Unlimited	€29.79	€29.79
Triple Play Bundles			
eircom Business Advantage	50Gb	€24.79	€49.58
eircom Business Advantage Boost	Unlimited	€29.79	€59.58

- The eircom Business Multi Broadband Bundle Promotion is not available on the following dual Play bundles :-
Talk Phone Unlimited + Business Advantage (DSL) - 24 mth / Talk Phone Local National + Business Advantage (eFibre) - 24 mth / Talk Phone Local National + Business Advantage (DSL) - 12 mth / Talk Phone Local National + Business Advantage Boost (DSL) - 24 mth / Talk Value + Business Advantage (eFibre) - 24 Mth / Talk Value + Business Advantage (NGB) - 24 mth / Talk Phone Line + Business Advantage (eFibre) - 18 Mth / Talk Phone Line + Business Advantage (eFibre) - 24 Mth / Talk Phone Line + Business Advantage (NGB) - 24 mth / Talk Phone Line + Business Advantage Boost (DSL) - 18 mth.
- The eircom Business Multi Broadband Bundle Promotion is not available on the following triple play bundles :-
Talk Phone Unlimited + Business Advantage (DSL) / Talk Phone Local National + Business Advantage (eFibre) / Talk Phone Local National + Business Advantage Boost (DSL) / Talk Value + Business Advantage (eFibre) / Talk Value + Business Advantage (NGB) / Talk Phone Line + Business Advantage (eFibre) / Talk Phone Line + Business Advantage (NGB) bundled with any eMobile Business plan on 24 months contract.. Talk Phone Line + Business Advantage (eFibre) / Talk Phone Line + Business Advantage Boost (DSL) bundled with any eMobile Business plan on 18 months contract. Talk Phone Local National + Business Advantage (DSL) bundled with any eMobile Business plan on 12 months contract.
- The eircom Business Multi Broadband Bundle Promotion is not available on any Standalone Broadband Bundle.
- Customers who avail of the promotion will receive one month or two months (see table above) free Broadband provided they continue to avail of a qualifying bundle.
- Promotional Period from 5th March 2014 to 31st August 2015.
- These terms and conditions will apply together with the terms and conditions governing the customer's use of the services included in their bundle.
- Offer subject to availability and line qualification.

eTalk, eFibre and eMobile Triple Play New and Winback Bundle Promotion
(effective from 07/03/15 to 30/06/15)
eircom Price List (Amendment NO 8) 2015

- promotion -

8 eircom reserve the right to withdraw this offer by giving relevant notice in accordance with normal requirements.

(effective from 07/03/15 to 30/6/15)
(see notes below)

Option 1

eTalk	Broadband	eMobile	Discount (inc VAT)	Discount (ex VAT)
eTalk Off-Peak	eFibre Advanced or eircom Broadband Advanced	eMobile 150 or eMobile 300 or eMobile 500 or eMobile Unlimited	€15	12.20

Option 1

eTalk	Broadband	eMobile	Discount (inc VAT)	Discount (ex VAT)
eTalk Off-Peak	eFibre Advanced (Unlimited) or eircom Broadband Advanced (Unlimited)	eMobile 150 or eMobile 300 or eMobile 500 or eMobile Unlimited	€15	12.20

Option 1

eTalk	Broadband	eMobile	Discount (inc VAT)	Discount (ex VAT)
eTalk Anytime	eFibre Advanced or eircom Broadband Advanced	eMobile 150 or eMobile 300 or eMobile 500 or eMobile Unlimited	€15	12.20

eTalk	Broadband	eMobile	Discount (inc VAT)	Discount (ex VAT)
eTalk Anytime	eFibre Advanced or eircom Broadband Advanced (Unlimited)	eMobile 150 or eMobile 300 or eMobile 500 or eMobile Unlimited	€38	30.89

Option 3

eircom Talk / eTalk	Broadband	eMobile	Discount (inc VAT)	Discount (ex VAT)
eTalk Anytime	eFibre Advanced (Unlimited) or eircom Broadband Advanced (Unlimited)	SIMO 150 or SIMO Unlimited	€23	18.70

	Number of Discount Instalments	Promotional Discount per Instalment		Total Promotional Discount	
Option 1	6	inc. VAT	€15.00	inc. VAT	€90.00
		ex Vat	€12.20	ex Vat	€73.17
Option 2	6	inc. VAT	€38.00	inc. VAT	€228.00
		ex Vat	€30.89	ex Vat	€185.37
Option 3	6	inc. VAT	€23.00	inc. VAT	€138.00
		ex Vat	€18.70	ex Vat	€112.20

1. The eTalk, eFibre and eMobile Triple Play New and Winback Bundle Promotion is made available to new and winback customers for those customers who sign up between March 7th 2015 and June 30th 2015 inclusive and avail of an eTalk, eFibre and eMobile Triple Play Bundle as outlined above.
2. Qualifying customers who avail of an eTalk, eFibre and eMobile Triple Play New and Winback Bundle Promotion will receive a monthly discount on their bill applicable to the first 6 months following sign up to the bundle.
3. The value of the discount will be as shown in the table above. The applicable discount option will be determined by the eTalk, Broadband and eMobile services selected by the customer as outlined.
4. Customers must remain on the eTalk, eFibre and eMobile Triple Play bundle and retain the eTalk, Broadband and eMobile services required for the the selected discount Option throughout the 6 month promotional period in order to avail of all 6 monthly instalments of promotional discount.
5. The promotion is made available subject to an 18 month contract term being applied to the bundle. For the avoidance of doubt, early cease charges will apply where eTalk, Broadband or eMobile service is ceased within the minimum contract period.
6. Customers availing of the promotion who change any eTalk, Broadband or eMobile component within the bundle (while retaining all components required for the selected discount Option) within the initial 6 months after availing of the promotion will continue to receive the bundle promotion for the outstanding term of the promotion only.
7. eircom reserves the right to withdraw this offer by giving relevant notice in accordance with normal requirements.
8. A customer may only avail of this promotion once.
9. These terms and conditions will apply together with the terms and conditions governing the customer's use of the components included in the bundle.

10. A customer may not avail of more than one eTalk Bundle Promotion simultaneously.

eircom Talk, eFibre and eMobile Triple Play New and Winback Bundle Promotion

(effective from 07/03/15 to 30/06/15)

Option 1

eircom Talk	Broadband	eMobile	Discount (inc VAT)	Discount (ex VAT)
eircom Talk Off-Peak	eircom Broadband Advanced	eMobile 150 or eMobile 300 or eMobile 500 or eMobile Unlimited	€15	12.20

Option 1

eircom Talk	Broadband	eMobile	Discount (inc VAT)	Discount (ex VAT)
eircom Talk Off-Peak	eircom Broadband Advanced (Unlimited)	eMobile 150 or eMobile 300 or eMobile 500 or eMobile Unlimited	€15	12.20

Option 1

eircom Talk	Broadband	eMobile	Discount (inc VAT)	Discount (ex VAT)
eircom Talk Anytime	eircom Broadband Advanced	eMobile 150 or eMobile 300 or eMobile 500 or eMobile Unlimited	€15	12.20

eircom Talk	Broadband	eMobile	Discount (inc VAT)	Discount (ex VAT)
eircom Talk Anytime	eircom Broadband Advanced (Unlimited)	eMobile 150 or eMobile 300 or eMobile 500 or eMobile Unlimited	€38	30.89

Option 3

eircom Talk	Broadband	eMobile	Discount (inc VAT)	Discount (ex VAT)
eircom Talk Anytime	eircom Broadband Advanced (Unlimited)	SIMO 150 or SIMO Unlimited	€23	18.70

(see notes below)

(effective from 07/03/15 to 30/06/15)

	Number of Discount Instalments		Promotional Discount per Instalment	Total Promotional Discount
Option 1	6	inc. VAT	€15.00	€90.00
		ex Vat	€12.20	€73.17
Option 2	6	inc. VAT	€38.00	€228.00
		ex Vat	€30.89	€185.37
Option 3	6	inc. VAT	€23.00	€138.00
		ex Vat	€18.70	€112.20

1. The eircom Talk, eFibre and eMobile Triple Play New and Winback Bundle Promotion is made available to new and winback customers for those customers who sign up between March 7th 2015 and June 30th 2015 inclusive and avail of an eircom Talk, eFibre and eMobile Triple Play Bundle as outlined above.
2. Qualifying customers who avail of an eircom Talk, eFibre and eMobile Triple Play New and Winback Bundle Promotion will receive a monthly discount on their bill applicable to the first 6 months following sign up to the bundle.
3. The value of the discount will be as shown in the table above. The applicable discount option will be determined by the eircom Talk, Broadband and eMobile services selected by the customer as outlined.
4. Customers must remain on the eircom Talk, eFibre and eMobile Triple Play bundle and retain the eircom Talk, Broadband and eMobile services required for the the selected discount Option throughout the 6 month promotional period in order to avail of all 6 monthly instalments of promotional discount.
5. The promotion is made available subject to an 18 month contract term being applied to the bundle. For the avoidance of doubt, early cease charges will apply where eircom Talk, Broadband or eMobile service is ceased within the minimum contract period.
6. Customers availing of the promotion who change any eircom Talk, Broadband or eMobile component within the bundle (while retaining all components required for the selected discount Option) within the initial 6 months after availing of the promotion will continue to receive the bundle promotion for the outstanding term of the promotion only.
7. eircom reserves the right to withdraw this offer by giving relevant notice in accordance with normal requirements.
8. A customer may only avail of this promotion once.
9. These terms and conditions will apply together with the terms and conditions governing the customer's use of the components included in the bundle.
10. A customer may not avail of more than one eircom Talk Bundle Promotion simultaneously.

eTalk, eFibre, eMobile and eVision Quad Play New and Winback Bundle Promotion

(effective from 07/03/15 to 30/06/15)

Option 1

eircom Price List (Amendment NO 8) 2015

Option 1

- promotion -

eircom Talk / eTalk	Broadband	eMobile	Discount (inc VAT)	Discount (ex VAT)
eircom Talk Off-Peak	eFibre Advanced	eMobile 150	€15	€12.20
or	or	or		
eTalk Off-Peak	eircom Broadband Advanced	eMobile 300		
		eMobile 500		
	eVision Essential	eMobile Unlimited		

eircom Talk / eTalk	Broadband	eMobile	Discount (inc VAT)	Discount (ex VAT)
eircom Talk Off-Peak	eFibre Advanced (Unlimited)	eMobile 150	€15	€12.20
or	or	or		
eTalk Off-Peak	eircom Broadband Advanced	eMobile 300		
		eMobile 500		
	eVision Essential	eMobile Unlimited		

Option 1

eircom Talk / eTalk	Broadband	eMobile	Discount (inc VAT)	Discount (ex VAT)
eircom Talk Anytime	eFibre Advanced	eMobile 150	€15	€12.20
or	or	or		
eTalk Anytime	eircom Broadband Advanced	eMobile 300		
		eMobile 500		
	eVision Essential	eMobile Unlimited		

Option 2

eircom Talk / eTalk	Broadband	eMobile	Discount (inc VAT)	Discount (ex VAT)
eircom Talk Anytime	eFibre Advanced (Unlimited)	eMobile 150	€50	€40.65
or	or	or		
eTalk Anytime	eircom Broadband Advanced	eMobile 300		
		eMobile 500		
	eVision Essential	eMobile Unlimited		

(effective form 07/03/15 to 30/06/15)
(see over)

eircom Talk / eTalk	Broadband	eMobile	Discount (inc VAT)	Discount (ex VAT)	<i>Option 3</i>
eircom Talk Anytime or eTalk Anytime	eFibre Advanced (Unlimited) or eircom Broadband Advanced (Unlimited) eVision Essential	SIMO 150 or SIMO Unlimited	€38	€30.89	

	Number of Discount Instalments		Promotional Discount per Instalment	Total Promotional Discount
Option 1	6	inc. VAT	€15.00	€90.00
		ex Vat	€12.20	€73.17
Option 2	6	inc. VAT	€50.00	€300.00
		ex Vat	€40.65	€243.90
Option 3	6	inc. VAT	€38.00	€228.00
		ex Vat	€30.89	€185.37

- The eTalk, eFibre, eMobile and eVision Quad Play New and Winback Bundle Promotion is made available to new and winback customers for those customers who sign up between March 7th 2015 and June 30th 2015 inclusive and avail of an eTalk, eFibre, eMobile and eVision Quad Play Bundle as outlined above.
- Qualifying customers who avail of an eTalk, eFibre, eMobile and eVision Quad Play New and Winback Bundle Promotion will receive a monthly discount on their bill applicable to the first 6 months following sign up to the bundle.
- The value of the discount will be as shown in the table above. The applicable discount option will be determined by the eTalk, Broadband, eMobile and eVision services selected by the customer as outlined.
- Customers must remain on the eTalk, eFibre, eMobile and eVision Quad Play bundle and retain the eTalk, Broadband, eMobile and eVision services required for the the selected discount Option throughout the 6 month promotional period in order to avail of all 6 monthly instalments of promotional discount.
- The promotion is made available subject to an 18 month contract term being applied to the bundle. For the avoidance of doubt, early cease charges will apply where eTalk, Broadband, eMobile or eVision service is ceased within the minimum contract period.
- Customers availing of the promotion who change any eTalk, Broadband or eMobile component within the bundle (while retaining all components required for the selected discount Option) within the initial 6 months after availing of the promotion will continue to receive the bundle promotion for the outstanding term of the promotion only.
- eircom reserves the right to withdraw this offer by giving relevant notice in accordance with normal requirements.
- A customer may only avail of this promotion once.
- These terms and conditions will apply together with the terms and conditions governing the customer's use of the components included in the bundle.
- A customer may not avail of more than one eFibre Bundle Promotion simultaneously.

eircom eVision online exclusive Experience Pack Promotion
(promotional period : 13th March to 31st December 2015)

Experience Pack Promotion

Promotional Offer	Standard Monthly Rate	
	ex. vat	inc. vat
FREE for 6 months	€6.50	€8.00

Notes:

- 1 The following terms and conditions of the Experience Pack free for 6 months promotion (the "Promotion") apply together with the eVision terms and conditions ("eVision Terms") and the Extended Pack terms and conditions ("Extended Pack Terms") which can be found at https://www.eircom.net/assets/static/pdf/tv/evision_tv_terms.pdf and all constitute a legally binding agreement between eircom Limited ("eVision") and the customer ("Customer").
- 2 The Promotion is available to all new eVision Customers who subscribe to the eVision Experience Pack online.
- 3 The Promotion can only be availed of by eligible Customers from 13th March to 31st December 2015 (the "Promotional Period").
- 4 The current monthly charge for the Experience Pack is €8.00 a month. A Customer who avails of the Promotion during the Promotional Period will receive the first six (6) months of the Experience Pack for free from the Operational Service Date for the Experience Pack. Thereafter i.e. upon expiry of the sixth free month the Customer will be subject to the standard monthly charge for the eVision Experience Pack and shall pay same in accordance with the eVision Terms.
- 5 eVision reserves the right to withdraw the Promotion by giving relevant notice to the Customer in accordance with the eVision Terms and the eVision Experience Pack terms and conditions.
- 6 Where a Customer who is availing of this Promotion terminates their eVision Experience Pack this Promotion will immediately cease to apply.
- 7 Where a Customer who is availing of this Promotion terminates their eVision service this Promotion will immediately cease to apply.
- 8 In the event of any conflict relating to the operation of the Promotion, the terms and conditions of the Promotion shall prevail over the eVision Terms and the Extended Pack Terms. Terms not herein defined shall have the meaning ascribed to them in the eVision Terms.

eircom eVision online exclusive Multiroom Service Promotion

(promotional period : 13th March to 31st December 2015)

Multiroom Service Promotion

Promotional Offer	Standard Monthly Rate	
	ex. vat	inc. vat
FREE for 6 months	€4.07	€5.00

Notes:

- 1 The following terms and conditions of the Multiroom Service free for 6 months promotion (the "Promotion") apply together with the eVision terms and conditions ("eVision Terms") and the Multiroom Service terms and conditions ("Multiroom Service Terms") which can be found at https://www.eircom.net/assets/static/pdf/tv/evision_tv_terms.pdf and all constitute a legally binding agreement between eircom Limited ("eVision") and the customer ("Customer").
- 2 The Promotion is available to all new eVision customers who subscribe to the Multiroom Service online.
- 3 The Promotion can only be availed of by eligible Customers from 13th March to 31st December 2015 (the "Promotional Period").
- 4 The current monthly charge for the Multiroom Service is €5.00 a month. A Customer who avails of the Promotion during the Promotional Period will receive the first six (6) months of the Multiroom Service for free from the Operational Service Date for the Multiroom Service. Thereafter i.e. upon expiry of the sixth free month the Customer will be subject to the standard monthly charge for the Multiroom Service and shall pay same in accordance with the eVision Terms.
- 5 eVision reserves the right to withdraw the Promotion by giving relevant notice to the Customer in accordance with the eVision Terms and the eVision Multiroom Service terms and conditions.
- 6 Where a Customer who is availing of this Promotion terminates their eVision Multiroom Service this Promotion will immediately cease to apply.
- 7 Where a Customer who is availing of this Promotion terminates their eVision service this Promotion will immediately cease to apply.
- 8 In the event of any conflict relating to the operation of the Promotion, the terms and conditions of the Promotion shall prevail over the eVision Terms and the Multiroom Service Terms. Terms not herein defined shall have the meaning ascribed to them in the eVision Terms.

eircom Consumer €5 opt-in contract promotion
(effective from 1st April 2015 to 31st December 2015)

PSTN	PSTN Line Rental (ex, VAT)	PSTN Line Rental (inc. VAT)	Once-off Promotion Discount (ex, VAT)	Once-off Promotion Discount (inc. VAT)
PSTN Monthly Line Rental	€20,96	€25.78	€4,07	€5.00

Notes:

1. This promotion is made available on an opt-in basis to all Residential eircom customers who have at least one PSTN line,
2. The promotion is not available to customers availing of eTalk Plans,
3. Customers who opt-in to the promotion will receive a once-off credit of €5,00 (inc VAT) on their next eircom bill following the opt-in,

4. The promotion is made available subject to the customer commencing a new 12 month minimum contract term on their PSTN service and a new 12 month minimum contract term on their Broadband service, where the customer is availing of broadband at the time that the promotion is applied, For the avoidance of doubt, an early cease charge will apply where the PSTN or Broadband service is ceased within the minimum contract term,

5. Only one instance of the €5 credit may apply to an account within a 12 month period,
6. eircom reserves the right to withdraw this offering by giving relevant notice in accordance with normal requirements,

7. Usage of eircom PSTN service is deemed to be acceptance of the eircom General Terms and Conditions of Telephone Service, Usage of any other Facilities such as Discount Plans, Special Tariff Plans, eircom Broadband and eircom Talktime and Broadband Bundles is deemed to be acceptance of the terms of those Facilities,

eircom Talk Anytime Promotion
(effective from 1st April 2015 to 31st December 2015)

eircom Talk Level	Standard Monthly Rental				Call Components (applies to eligible eircom Talk Calls only)	Promotional Monthly Rental for first 6 months				Promotional Monthly Rental after initial 6 month period			
	PSTN Price (inc. vat)	PSTN Price (ex. vat)	ISDN Price (inc. vat)	ISDN Price (ex. vat)		PSTN Price (inc. vat)	PSTN Price (ex. vat)	ISDN Price (inc. vat)	ISDN Price (ex. vat)	PSTN Price (inc. vat)	PSTN Price (ex. vat)	ISDN Price (inc. vat)	ISDN Price (ex. vat)
eircom Talk Anytime/ eircom Talk Anytime 2014	€43.00	€34.96	€55.00	€47.15	Unlimited Anytime Local, National calls and 30 Anytime minutes to Irish Mobile Operators	€30.00	€24.39	€45.00	€36.59	€35.00	€28.46	€52.99	€43.08

Notes:

- 1 The eircom Talk Anytime Promotion is available to customers availing of eircom Talk Anytime / eircom Talk Anytime 2014 only.
- 2 For the avoidance of doubt, the eircom Talk Anytime Promotion is not available to customers of any eircom Talk Levels other than those listed at 1 above or to a customer on any eircom voice and broadband bundle, including both eircom Talktime and eircom Talk bundles.
- 3 The eircom Talk Anytime Promotion can only be availed of by eligible customers from 1st April 2015 to 31st December 2015.
- 4 A customer who avails of this eircom Talk promotion is not eligible for any other eircom Talk promotion for a period of 18 months.
- 6 Customers who avail of the eircom Talk Anytime Promotion will receive a credit of €10 (inc. VAT) each month against their bill for a period of 6 months from the date on which the customer first avails of the eircom Talk Anytime Promotion, after which time a credit of €5 (inc. VAT) will apply against their bill each month.
- 6 Where a customer who is availing of this promotion opts into a broadband bundle, the eircom Talk Anytime Promotion will cease to be applied to the customer's bill.
- 7 Customers who availed of any previously available iteration of the eircom Talk Anytime Promotion cannot avail of the Promotional monthly Rental for first 6 months applicable to this promotion.
- 8 Where a customer ceases the eircom Talk plan with which this eircom Talk Anytime Promotion is associated, the eircom Talk Anytime Promotion will cease to be applied to the customer's bill.
- 9 eircom reserve the right to withdraw this offer by giving relevant notice in accordance with normal requirements.
- 10 These terms and conditions will apply together with the terms and conditions governing the customer's use of their eircom Talk package.

eircom Price List (Amendment N
Notes:

Use your Own Modem Promotion	Promotional Credit on Modem	
	ex. vat	inc. vat
	€24.39	€30.00

- promotion -

1 The offer is available on eircom broadband Advanced, eircom broadband Advanced unlimited, eircom Broadband Solo Advanced NGB, eircom Broadband Solo Advanced Unlimited NGB.

2 The offer is only available to customers that apply to connect their existing broadband connection to eircom and don't require a new modem from eircom from April 1st 2015 to March 31st 2016.

3 The offer is only available to customers that apply to connect their existing broadband connection to eircom during the promotion period and don't require a new modem.

4 Customers who sign up to the offer will receive a €30 incl. VAT credit on their next eircom bill (or over their next two bills if billed monthly).

5 If you are unable to get your existing modem working on the eircom network and you require a free new modem from eircom then you will not be able to avail of the offer.

6 Usage of eircom Broadband service is deemed acceptance of the general eircom Broadband terms and conditions which shall prevail.

7 Customers may only avail of one eircom broadband per telephone line.

8 eircom reserve the right to withdraw this offer by giving relevant notice in accordance with normal requirements. eircom Broadband is not necessarily available on

9 all lines in all areas and this is subject to availability and line qualification.

10 The promotion is not available to existing eircom Broadband customers

eircom Consumer Once-off Bundle Promotion

(effective from 16/04/15 to 30/06/15)

Available with any bundle that includes:		
Fixed Line	plus	Broadband
eTalk Off Peak or eTalk Anytime or eircom Talk Weekend or eircom Talk Off Peak or eircom Talk Anytime		Any eircom Broadband Package
Number of Discount Instalments	Total Promotional Discount	
1	inc vat	ex. Vat
	€50.00	€40.65

Notes :

- 1 The eircom Consumer Once-off Bundle Promotion is made available to new and winback customers availing of an eircom Talk or eTalk and Broadband bundle from April 1st to June 30th 2015.
- 2 Customers who avail of the promotion will receive a once-off credit of €50 (inc Vat) / €40.65 (ex VAT) on their first bill following sign-up to the bundle.
- 3 Customers must have an active or eircom Talk/ eTalk and Broadband bundle on their first bill in order to avail of the promotion.
- 4 The promotion is made available subject to a 12 month (eircom Talk Bundles) or 18 month (eTalk Bundle) contract term being applied to the bundle. For the avoidance of doubt, early cease charges will apply where any service is ceased within the minimum contract period.
- 5 eircom reserves the right to withdraw this offer by giving relevant notice in accordance with normal requirements.
- 6 A customer may only avail of this promotion once.
- 7 These terms and conditions will apply together with the terms and conditions governing the customer's use of the components included in the bundle.

	Number of Discount Instalments	Promotional Discount per Instalment		Total Promotional Discount	
Option 2	12	inc vat	ex. Vat	inc vat	ex. Vat
		€3.00	€2.44	€36.00	€29.27
Notes :	Fixed Line	plus	Broadband		
	eTalk Off Peak or eTalk Anytime or eircom Talk Weekend or eTalk Off Peak or eTalk Anytime		Any Consumer Broadband Package		

- promotion -

- 1 The eircom Consumer Re-Contracting Bundle Promotion is made available to customers availing of a new or amended eircom Talk or eTalk and Broadband bundle from October 1st 2014 to January 31st 2015.
- 2 Customers who avail of the eircom Consumer Re-Contracting Bundle Promotion may choose one of the three discount options outlined above.
- 3 Customers must remain on one of their eircom Talk/ eTalk and Broadband bundle throughout the applicable promotional period in order to avail of all monthly instalments of promotional discount.
- 4 The promotion is made available subject to a 12 month (eircom Talk Bundles) or 18 month (eTalk Bundle) contract term being applied to the bundle. For the avoidance of doubt, early cease charges will apply where any service is ceased within the minimum contract period.
- 5 eircom reserves the right to withdraw this offer by giving relevant notice in accordance with normal requirements.
- 6 A customer may only avail of this promotion once.
- 7 Customers availing of **Option 1** above may not avail of any other bundle promotion.
- 8 These terms and conditions will apply together with the terms and conditions governing the customer's use of the components included in the bundle.

Sky Premium Add-On Trial

(promotional period : 16th April 2015 to 31st December 2015)

SKY Trial	Normal Price		Trial Price		Trial Price Duration
	ex vat	inc vat	ex vat	inc vat	
Sky Sports	€29.27	€36.00	€0.00	€0.00	1 month
Sky Movies	€19.51	€24.00	€0.00	€0.00	1 month
Sky Sports & Movies	€37.40	€46.00	€0.00	€0.00	1 month

Notes:

- 1 The following terms and conditions of the Sky Premium Add-On 1 month free trial (the "Promotion") apply together with the eVision terms and conditions ("eVision Terms") and the Premium Channel Pack terms and conditions ("Premium Channel Pack Terms") which can be found at https://www.eir.ie/assets/static/pdf/tv/evision_tv_terms.pdf and all constitute a legally binding agreement between eircom Limited ("eVision") and the eVision customer ("Customer").
- 2 The Promotion is available to all new eVision customers and existing eVision customers who have not signed up to the Sky Premium Add-On or existing eVision customers who signed up to the Sky Premium Add-On more than 12 months ago and who subsequently terminated same ("Eligible Customers").
- 3 The Promotion can only be availed of by Eligible Customers from 16 April 2015 until 31 December 2015.
- 4 In the event there are a number of promotions being offered at the same time for the Sky Premium Add-Ons an Eligible Customer can only avail of one promotion.
- 5 A Customer who avails of the Promotion will receive the first month of Sky Premium Add-On for free from the Operational Service Date for the Sky Premium Add On. Thereafter the Customer will be subject to the standard monthly charge for Sky Premium Add-On as set out above and shall pay same in accordance with the eVision Terms.
- 6 eVision reserves the right to withdraw the Promotion by giving relevant notice to the Customer in accordance with the eVision Terms and the Premium Channel Pack Terms.
- 7 A Customer may terminate the Sky Premium Add-On in accordance with the Premium Channel Pack Terms.
- 8 Where a Customer who is availing of this Promotion terminates their eVision service this Promotion will immediately cease to apply.
- 9 In the event of any conflict relating to the operation of the Promotion, the terms and conditions of the Promotion shall prevail. Terms not herein defined shall have the meaning ascribed to them in the eVision Terms and the Premium Channel Pack terms and conditions.

Number of Discount Instalments	Promotional Discount per Instalment	Total Promotional Discount
6	€20.00	€120.00

- 1 The eircom Business Multi Product Bundle Promotion is available for new connections to Dual Play (PSTN & BB) Bundles which include Business Talk Unlimited / Business Talk Local & National + (eFibre & NGB) Business Advantage / Business Advantage Boost excluding Business Talk Local National & Business Advantage (eFibre) on a 24 month contract.
- 2 The eircom Business Multi Product Bundle Promotion is available for new connections to Triple Play Bundles which include as above bundled with eMobile Business 200 1GB or eMobile Business Unlimited 15GB excluding Business Talk Local National & Business Advantage (eFibre) on a 24 month
- 3 The eircom Business Multi Product Bundle Promotion is not available on any Business Talk Phone Line or Business Talk Value Bundle
- 4 Customers who avail of the promotion will receive a monthly credit of €20.00 per month (ex VAT) on their eircom bill for 6 months, provided they continue to avail of a qualifying bundle.
- 5 Promotional Period from 1st May to September 30th 2015.
- 6 These terms and conditions will apply together with the terms and conditions governing the customer's use of the services included in their bundle.
- 7 Offer subject to availability and line qualification.
- 8 eircom reserve the right to withdraw this offer by giving relevant notice in accordance with normal requirements.